

Propaq® Encore Vital Signs Monitor



Reference Guide

Models 202EL, 204EL, 206EL
Software version 2.5X

WelchAllyn®

Advancing Frontline Care™

© 2009 Welch Allyn. All rights are reserved. No one is permitted to reproduce or duplicate, in any form, this manual or any part thereof without permission from Welch Allyn.

Welch Allyn assumes no responsibility for any injury to anyone, or for any illegal or improper use of the product, that may result from failure to use this product in accordance with the instructions, cautions, warnings, or statement of intended use published in this manual.

Welch Allyn, Propaq, Acuity, and Smartcuf are registered trademarks of Welch Allyn.

SET and Masimo are registered trademarks of Masimo Corporation. Possession or purchase of a Masimo SpO₂-equipped monitor does not convey any express or implied license to use the device with unauthorized sensors or cables which would, alone or in combination with this device, fall within the scope of one or more of the patents relating to this device.

Nellcor and Oximax are registered trademarks of Nellcor Puritan Bennett.

Software in this product is copyright by Welch Allyn or its vendors. All rights are reserved. The software is protected by United States of America copyright laws and international treaty provisions applicable worldwide. Under such laws, the licensee is entitled to use the copy of the software incorporated with this instrument as intended in the operation of the product in which it is embedded. The software may not be copied, decompiled, reverse-engineered, disassembled or otherwise reduced to human-perceivable form. This is not a sale of the software or any copy of the software; all right, title and ownership of the software remain with Welch Allyn or its vendors.

For information about any Welch Allyn product, call the nearest Welch Allyn representative:

USA	+ 1 315 685 4560 800 535 6663	Australia	+ 61 2 9638 3000 800 074 793
Canada	800 561 8797	China	+ 86 216 327 9631
European Call Center	+ 35 3 46 906 7790	France	+ 33 1 60 09 33 66
Germany	+ 49 7477 92 71 86	Japan	+ 81 3 3219 0071
Latin America	+ 1 305 669 9003	Netherlands	+ 31 15 750 5000
Singapore	+ 65 6419 8100	South Africa	+ 27 11 777 7555
United Kingdom	+ 44 20 7365 6780	Sweden	+ 46 8 58 53 65 51

REF 810-1719-XX (CD)

REF 810-2106-XX (Printed, English only)

Manual Part Number 810-0640-06 Ver A 2009-10



Welch Allyn, Inc.
8500 SW Creekside Place
Beaverton, OR 97008-7107 USA



Welch Allyn Ltd
Navan Business Park
Dublin Road, Navan
County Meath, Republic of Ireland

www.welchallyn.com



Contents

1 - General information	1
Safety summary	1
Symbols	3
Propaq Encore documentation	5
The documentation set	5
About this reference guide	5
Statement of expectations of the reader	5
2 - Getting started	7
Introducing the Propaq Encore	7
Intended use	7
Propaq Encore models and options	7
Expansion module	8
Propaq Encore pulse oximetry option (SpO ₂)	8
Capnography (CO ₂) options	8
Impedance pneumography (RESP) option	8
Printer option	8
Propaq-to-Acuity® option	9
Modem-Propaq option	9
HP-compatible side panel option	9
Using the Propaq Encore	9
System controls (right side panel)	9
Alarm lights	10
Power-up screen	11
Patient connections	13
Propaq Encore display	15
Propaq Encore buttons	16
Propaq Encore menus	17
Monitor setup	20
Selecting waveforms for display	22
Setting the time and date	22
Changing the date format, filter, and units	23
Setting the current, custom, and power-up modes	23
Printer functions	25
Learning the Propaq Encore	26
Using in-service mode	26
What you can do with in-service mode	27
What you cannot do with in-service mode	27
Confirm and learn alarm behavior in the in-service mode	27

3 - Patient monitoring	29
ECG/RESP	29
Intended use—impedance pneumography (RESP)	29
Intended use—ECG	30
ECG connector and applicable accessories	31
Preparation	31
How ECG/RESP is displayed	33
Using the Propaq Encore with pacemaker patients	35
Using the filter to better display a waveform	36
Simultaneous equipment alerts	36
ECG messages	36
RESP messages	36
Invasive pressure	37
Intended use	37
Invasive pressure connectors and transducers	37
Preparation	38
Rezeroing a transducer	39
How invasive pressure is displayed	39
Invasive pressure messages	41
NIBP	42
Intended use	42
Improve NIBP accuracy with Smartcuf®	43
NIBP connector and cuffs	44
Preparation	44
Important information about automatic measurements	48
NIBP messages	48
Temperature	50
Intended use	50
Temperature connectors and probes	50
Preparation	50
How temperature is displayed	51
Temperature messages	51
Pulse oximetry (SpO ₂)	52
Perform SpO ₂ monitoring with Masimo option	53
Perform SpO ₂ monitoring with Nellcor option	54
Perform SpO ₂ “spot-cCheck” monitoring	56
Capnography (CO ₂)	57
Intended use	57
CO ₂ measurements and display	58
CO ₂ display menus and status window	59
Mainstream CO ₂ monitoring	61
How to set up the CO ₂ channel and alarm limits	62
Sidestream CO ₂ monitoring	64
CO ₂ messages	66
4 - Alarms and limits	69
Description of alarm and alert tone patterns	69
Silence an active patient alarm or equipment alert tone for 90 seconds	69
Silence an alarm or alert tone for 90 seconds	69
Re-enable an alarm or alert tone before the 90-second silence period has elapsed	70

Indications during a 90-second silence period	70
Inhibit alarm and alert tones for four minutes: 4 SUSPND	70
Initiate a four-minute suspend period	70
Resume alarm and alert tone capability before the four-minute period has elapsed	70
Indications during a four-minute suspend period	70
Inhibit alarm and alert tones indefinitely: ALL ALARMS	71
Indefinitely suspend all alarm and alert tones	71
Resume all alarm and alert tone capability	71
Indications during an all-alarms suspended period	71
Summary of alarm and alert keys and Acuity Central Station messages	72
Alarm holdoffs	73
Propaq audio and visual alarm hold-offs	73
Propaq audio alarm hold-off with Acuity	73
Setting alarm limits	74
Adjust limits with STAT SET	74
Power-up equipment alert: program fault, settings lost	75
Troubleshooting system error messages	75
5 - Trends	77
The trend status window and menu	77
How trends are accumulated	77
NIBP trends	78
Displaying trends	78
Selecting a trend (NXT TRND)	78
6 - Printing	79
Printing patient data	79
Printing waveforms	79
Printing NIBP measurements	80
Printing the apnea ticket	81
Printing when a patient alarm occurs	81
OxyCRG	82
Printing trends	83
Printing a single trend	83
Printing several trends	83
Automatic trend prints	83
7 - Acuity Central Monitoring system	85
Intended use	85
Connecting to the Acuity system	85
Key-press route to Acuity menu	87
Press NET OFF to disconnect from Acuity	87
Printing at Acuity	87
Network alert message	88
8 - Power sources	89
Power adapter intended use	89
Verifying proper power-adapter configuration	89
Replacing the power-adapter fuses	90
Battery care	91
Recharging time	91

Monitor functions resumed	91
Operating times using battery power	91
Monitor functions based on battery voltage	92
Checking battery voltage	92
Replacing the fuse	92
9 - Care and maintenance	93
Avoid electrostatic discharge	93
Inspect and clean the monitor and accessories	93
Maintenance	94
Service interval recommendations	94
Recycling monitor components	95
Within the European Union	95
Outside the European Union	95
Monitor care	95
Environmental operating and storage limits	95
Extended storage precautions	95
Printer paper removal	96
Printer maintenance	96
Customer services	97
Ordering and customer service	97
Technical service	97
Repacking	97
10 - Specifications	99
ECG	99
Real-time ECG analog/defib sync	101
Impedance pneumography (RESP)	102
Invasive pressure	103
NIBP	104
Temperature	105
Pulse oximetry (SpO ₂)	106
Masimo	106
Nellcor	107
Capnography (CO ₂)	108
Mainstream CO ₂	109
Sidestream CO ₂	110
Alarms	111
Trends	111
Display	112
Monitor (environmental)	113
Monitor (physical)	114
Printer	115
Power	116
Power adapters	117
Factory default settings	118
In-service simulated values	120
EMC compliance	121
Glossary	13

1

General information

Safety summary

This Safety Summary should be read by all Propaq Encore users. Specific warnings and cautions will be found throughout the Propaq Encore documentation where they apply.



WARNING This monitor is to be operated by qualified personnel only. The operator of this monitor should read this entire manual, the monitor reference guide or directions for use, and all accessory directions for use before operating the monitor.

WARNING Place the Propaq monitor and accessories in locations where they cannot harm the patient if they fall from their shelf or mount. Lift the monitor only by its handle; do not lift it by any attached cables.

WARNING Do not connect more than one patient to a monitor. Do not connect more than one monitor to a patient.

WARNING Do not use the Propaq Encore in an MRI suite or a hyperbaric chamber.

WARNING Do not autoclave the Propaq. Autoclave accessories only if the manufacturer's instructions clearly approve it. Many accessories can be severely damaged by autoclaving.

WARNING Inspect the power adapter cord periodically for fraying or other damage, and replace the adapter as needed. Do not operate the apparatus from mains power with a damaged power adapter cord or plug.

WARNING When using a power adapter with this monitor, be sure to connect the power adapter to a three-wire, grounded, hospital-grade receptacle. Do not under any circumstances attempt to remove the grounding conductor from the power plug of the power adapter. Do not plug the power adapter into an extension cord. If there is any doubt about the integrity of the protective earth ground of the receptacle for the power adapter, do not plug in the power adapter; operate the monitor only on battery power. Contact your biomedical engineering department for assistance in identifying the proper power receptacle and making appropriate power connections.

WARNING Make frequent electrical and visual checks on cables and electrode wires.

WARNING Avoid electrosurgery burns at monitoring sites by ensuring proper connection of the electrosurgery return circuit so that the return paths cannot be made through monitoring electrodes and probes.



WARNING During defibrillation, keep the discharge paddles away from ECG and other electrodes, as well as other conductive parts in contact with the patient. Avoid contact with any accessories connected to the Propaq's left side panel.

WARNING To ensure patient safety, the conductive parts of the ECG electrodes (including associated connectors) and other patient-applied parts should not contact other conductive parts, including earth ground, at any time.

WARNING Do not operate this product in the presence of flammable anesthetics or other flammable substance in combination with air, oxygen-enriched environments, or nitrous oxide; explosion can result.

WARNING Within certain governmental jurisdictions, all interconnected accessory equipment must be labeled by an approved testing laboratory. After interconnection with accessory equipment, risk (leakage) current and grounding requirements must be maintained.

WARNING To ensure conformance to risk (leakage) current requirements when operating from an ac mains power source, use only a Welch Allyn® 503-0054 series power adapter.

WARNING This monitor should only be repaired by qualified service personnel. The operator should not attempt to open the monitor case or perform any maintenance on the monitor except for procedures explicitly described in this manual that can be performed by operators such as inspection and cleaning.

WARNING To ensure patient safety, use only accessories recommended or supplied by Welch Allyn. For a list of those accessories, see the Welch Allyn *Products and Accessories* guide (810-0409-XX), which accompanies this manual. Accessories must be used according to your hospital's standards and the manufacturer's recommendations. Always refer to the manufacturer's directions for use. Use of accessories not recommended by Welch Allyn may result in increased electromagnetic emissions or decreased electromagnetic immunity of the equipment.

WARNING Safe interconnection between the Propaq monitor and other devices must comply with applicable medical systems safety standards such as IEC 60601-1-1. Within certain governmental jurisdictions, all interconnected accessory equipment must be labeled by an approved testing laboratory. After interconnection with accessory equipment, risk (leakage) current and grounding requirements must be maintained.

WARNING As with all medical equipment, carefully route the patient cabling to reduce the possibility of patient entanglement or strangulation.

WARNING A product that has been dropped or severely abused should be checked by qualified service personnel to verify proper operation and acceptable risk (leakage) current values.

WARNING The pulse oximetry channel should NOT be used as an apnea monitor.

WARNING Do not use the pulse oximeter as a replacement or substitute for ECG-based arrhythmia analysis.



WARNING If the monitor detects an unrecoverable problem, an error message window appears containing an error number and a short message. Report such errors to Welch Allyn.

WARNING When taking NIBP measurements, periodically observe the patient's limb to make sure that the circulation is not impaired for a prolonged period of time. Also make sure the blood pressure cuff is properly placed according to *Propaq Encore Directions for Use* or *Propaq Encore Reference Guide*. Be especially careful when using the short-term automatic mode (TURBOCUF). Prolonged impairment of circulation or improper cuff placement can cause contusions.

WARNING The range of values measured by the monitoring parameters is provided in the Specifications section of *Propaq Encore Directions for Use* or *Propaq Encore Reference Guide*. Operation of the monitor outside the range of specified values is not recommended and may cause inaccurate results.

WARNING Electronic equipment that emits very strong electromagnetic or radio frequency signals can cause electrical interference with monitor operation, including causing the monitor to turn off power. Avoid operating this monitor near such equipment. For guidance about electromagnetic emissions and the recommended separation distance between the monitor and such equipment, refer to the specifications section of this manual.



Caution Changes or modifications not expressly approved by Welch Allyn could void the purchaser's authority to operate the equipment.

Caution Federal (U.S.A.) law restricts this device to sale, distribution, or use by or on the order of a licensed medical practitioner.

The Propaq Encore should be serviced only by a Welch Allyn service technician while under warranty. *Propaq Encore Service Manual* (810-0696-XX) is available from Welch Allyn to assist the biomedical engineer during post-warranty period service.

Symbols

The following symbols may appear on the Propaq Encore monitor or accessories or documentation. These internationally recognized symbols are defined by the International Electrotechnical Commission, IEC 878 and IEC 417A.



WARNING Indicates conditions that could lead to illness, injury, or death.























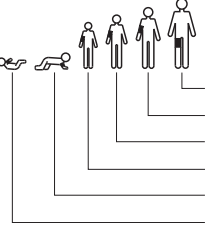



Caution In this manual, indicates conditions that could damage equipment or other property.



Caution On the product, means "Consult the accompanying documentation."

	Off (Standby)		Patient connections are Type CF, isolated for direct cardiac application, and protected against defibrillation.		Transformer meets requirements of a short-circuit-proof safety-isolating power transformer.
	On				Alternating current

	For continued fire protection, use only the specified fuse.		Patient connections are Type BF, and protected against defibrillation.		For indoor use only (on power adapter only)
	Direct current		Patient connections are Type B.		Caution: On the product, means "Consult accompanying documentation."
	Battery charging when green indicator illuminated	IPX1	Enclosure Protection Drip proof: Classification IPX1 per IEC Publication 529	CE	The CE Mark signifies the device has met all essential requirements of European Medical Device Directive 93/42/EEC for a Class 1 product. (This symbol is on the Universal Power Adapter.)
CE 0297	The CE Mark and Notified Body Registration Number signify the device has met all essential requirements of European Medical Device Directive 93/42/EEC.	 NRTL/C Evaluated to CSA 601-1 and UL5081-1	The Canadian Standards Association has evaluated this device according to CSA 601-1 and Underwriters Laboratory Standard UL 2601-1. (This symbol is on the Universal Power Adapter.)		
			Input port		Temperature sensor input
	Two way communication port		Output port		Single-use only (not reusable).
 <p>NIBP cuff sizes: Thigh Large adult Adult Small adult Child Infant</p>					Apply the NIBP cuff as shown.
	Non-ionizing electromagnetic radiation		Fuse		
 Pb	Separate lead acid battery from other disposables for recycling		Recycle the monitor and battery separately from other disposables. www.welchallyn.com/weee		
	Temperature limits		Stacking limit (by number)		Altitude limit
	Humidity limit		Keep away from rain		Fragile
	This device has been tested and certified by the Canadian Standards Association International to comply with applicable U.S. and Canadian medical safety standards.				

Propaq Encore documentation

The documentation set

The Propaq Encore documentation set consists of documents for the clinician, the biomedical technician, and the department head or purchaser of accessories for the Propaq Encore monitors.

This *Propaq Encore Reference Guide* contains important safety and operating information for the clinician.

Propaq Encore Service Manual (810-0696-XX) contains information on how to properly maintain the Propaq Encore through routine calibration, inspection, and maintenance.

Welch Allyn Products and Accessories guide (810-0409-XX) provides a comprehensive list of accessories recommended for Propaq Encore monitors and options.

About this reference guide

This Reference Guide provides descriptions and operating information for the Propaq Encore models 202EL, 204EL, and 206EL, including all available options at the time of this manual's printing.

Statement of expectations of the reader

This Reference Guide was written for the clinician. Although this guide may describe some monitoring techniques, Welch Allyn expects that you are a trained clinician who knows how to take and interpret a patient's vital signs. The Propaq Encore has been designed as a quality monitor; however, inherent limitations require that good clinical judgment always prevails.

2

Getting started

Introducing the Propaq Encore

Intended use

Before using the Propaq Encore on a patient, be sure you understand the Safety Summary at the front of this book. It provides important information about safely using the Propaq Encore. The Propaq Encore monitor is intended to be used by skilled clinicians for multiparameter vital signs monitoring of neonatal, pediatric, and adult patients in health care facility bedside applications; as well as for intra- and interfacility transport.

Propaq Encore monitors that do not include CO₂ or printer options are able to withstand light rain exposure over short periods of time (uniform distribution of approximately 1 mm of water/ minute for 10 minutes or less).

Propaq Encore models and options

Three models of Propaq Encore monitors are available.

Features common to all models	ECG, 3-lead or 5-lead configurations, 0.05-40/0.5-40 Hz NIBP, with neonatal, pediatric and adult modes Temperature, 2 channels: YSI 400 and 700 series-compatible connectors Defibrillator Synchronization Real-time Analog output of ECG Electrocautery noise suppression on all channels except Impedance Pneumography
206EL	Two Invasive Pressure Channels
204EL	One Invasive Pressure Channel
202EL	No Invasive Pressure
Options available for each model	Pulse Oximetry (SpO ₂) Capnography (CO ₂) (available only with SpO ₂): Mainstream Capnography (MCO ₂) Sidestream Capnography (SCO ₂) Dualstream Capnography (Both MCO ₂ and SCO ₂) Impedance Pneumography (RESP) (available only with SpO ₂) Printer HP-compatible side panel

Expansion module

The Propaq Encore Expansion Module attaches to the monitor and houses additional capabilities. The Expansion Module can be fitted with the SpO₂, CO₂, and Printer options.

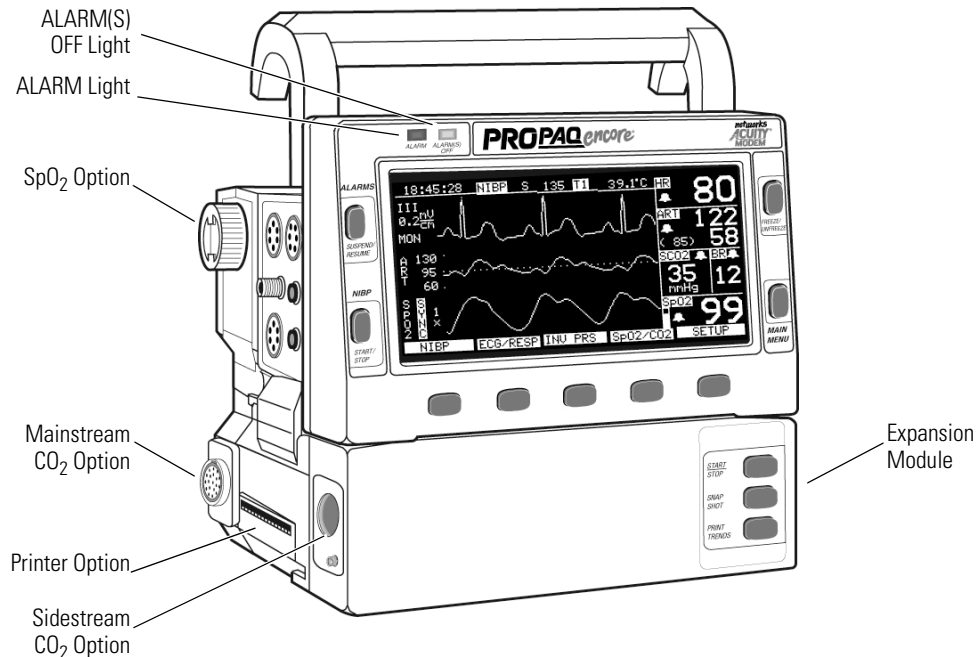

Propaq Encore pulse oximetry option (SpO₂)

The Propaq Encore Pulse Oximetry option (SpO₂) is installed in the Expansion Module or in a smaller unit that attaches to the rear of the monitor:

- Masimo[®] Pulse Oximetry option
- Nellcor[®] Pulse Oximetry option

Capnography (CO₂) options

The Propaq Encore CO₂ options allow carbon-dioxide monitoring. The mainstream CO₂ option and sidestream CO₂ option allow CO₂ monitoring directly in the breathing circuit of a ventilator. The sidestream CO₂ option also allows CO₂ monitoring of non-intubated patients through a cannula. The CO₂ options can be installed separately, or together as Dualstream CO₂ in the Expansion Module. These options require the Pulse Oximetry (SpO₂) option.

Impedance pneumography (RESP) option

The RESP option detects the rate or absence of respiratory effort, and is configured with the Pulse Oximetry option.

Printer option

The Expansion Module with Printer (EMP) provides a lightweight 3-channel recorder.

Propaq-to-Acuity® option

This option allows communication between the Propaq Encore and the Acuity Central Monitoring System by means of an ethernet network system installed in your facility. The Acuity System operator can view the patient data and control most of the bedside Propaq functions. The Propaq Encore connects to the Acuity System through an Acuity network cable that plugs into the Propaq right side panel.

Modem-Propaq option

This option allows telecommunication between a Propaq Encore and the Acuity System by means of external modems. This option is configured with the Propaq-to-Acuity option. For more information refer to *Modem-Propaq Reference Guide*.

HP-compatible side panel option

The HP connector-compatible option makes the Propaq Encore compatible with many Hewlett-Packard sensors and accessories used with the Hewlett Packard Component Monitoring System. This option replaces the standard Propaq Encore left side panel.

Using the Propaq Encore

System controls (right side panel)

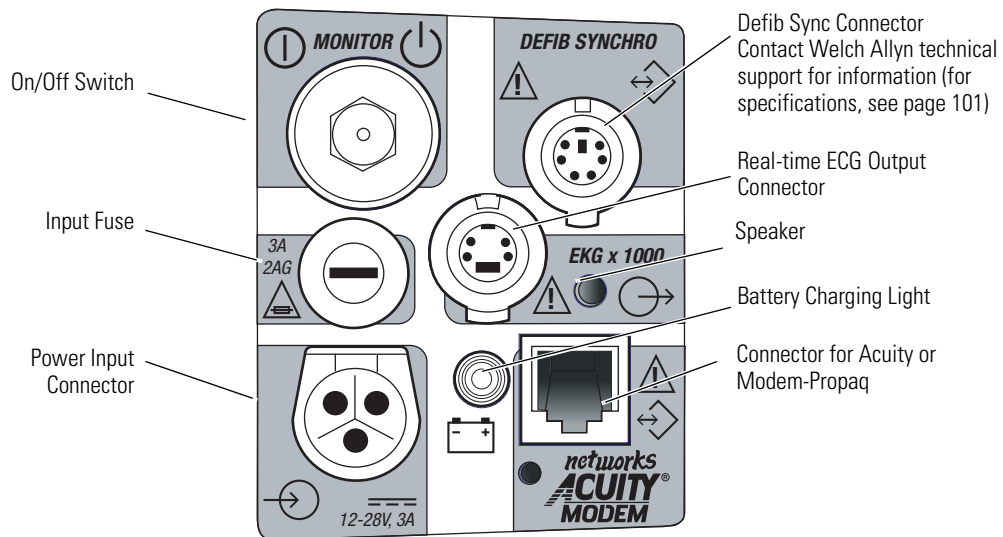

WARNING Safe interconnection between the Propaq Encore and other devices must comply with applicable medical systems safety standards such as IEC 60101-1.

On/Off switch

This switch turns the monitor on and off. The switch is recessed to prevent accidentally turning off the monitor, which would result in losing patient data.

Input fuse

The input fuse, which protects the Propaq Encore against power surges, is a 3-Ampere fuse, externally replaceable by qualified service personnel. See [“Replacing the fuse”](#) on page 92 for fuse replacement instructions.

Power input connector

This receptacle accepts the Welch Allyn ac power adapter, which must be used for ac mains operation and battery charging. The Propaq Encore is also designed to operate with other 12-28 volt, dc-only power sources, such as a vehicle battery system.

Defib sync connector

This connector allows connection with a LIFEPAK 5 or LIFEPAK 6s defibrillator for synchronized cardioversion. See [“Real-time ECG analog/defib sync”](#) on page 101.

Real-time ECG output connector

This connector provides a real-time analog ECG signal output.

Battery charging light

This green light turns on when a power source (ac power adapter or external dc source) is connected and the battery is charging. Although the monitor may be turned off, battery charging continues when an external power source is connected.

Connector for Acuity or Modem-Propaq

This connector allows either direct connection to an Acuity System, or connection to an external modem for telecommunication to an Acuity System. For more information about the Acuity System, see [“Acuity Central Monitoring system”](#) on page 85. For more information about the Modem-Propaq, refer to *Modem-Propaq Reference Guide*.

Alarm lights

Alarms and limits are described in detail beginning on [“Alarms and limits”](#) on page 69.

ALARM light

When an alarm limit is violated, the red **ALARM** light turns on.

ALARM(S) OFF light

When any alarm limit is turned off, the yellow **ALARM(S) OFF** light turns on.

Power-up screen

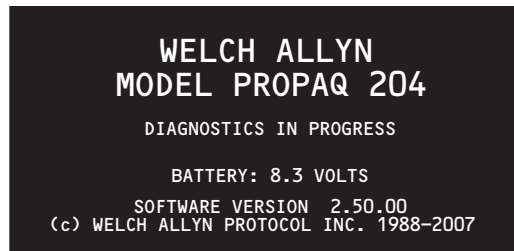

When you first turn on the monitor, the power-up screen displays information about the Propaq Encore and the monitor runs diagnostic tests to ensure proper functioning.

A few seconds later, the top two lines of the screen are replaced with text indicating the current patient mode (adult, pediatric, or neonatal).

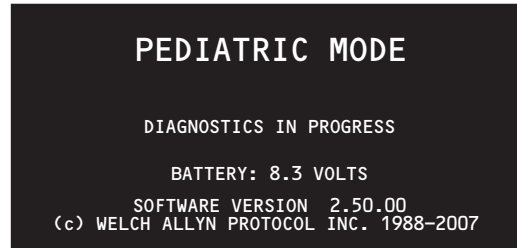

WARNING Before you use a Propaq on a new patient, always turn off the Propaq for a few seconds, then turn it on again. This clears the prior patient's trend values, alarm limit settings, and NIBP cuff inflation target.

1. If the Propaq Encore has been used for a previous patient, switch the monitor off, then on again. The monitor will turn on in the powerup patient mode with the associated settings.

Note Verify that the powerup tone is produced. If the monitor has SpO₂, verify two tones are produced to make sure that both speakers are working.

2. Verify the monitor is in the correct patient mode according to the patient's age. If the patient mode is not correct, change it. (See "[Monitor setup](#)" on page 20 to change the patient mode.)



WARNING Always check the patient mode when monitoring a new patient. The patient mode determines default alarm limits, maximum cuff inflation pressure, and internal algorithm settings.

3. Verify the battery voltage is sufficient for monitoring. If it is less than 7.4 V, connect to a power adapter (see "[Power adapter intended use](#)" on page 89 for information about the power adapter).

Power-up equipment alert: program fault, settings lost

If a PROGRAM FAULT: SETTINGS LOST, TIME/DAY RESET equipment alert appears when you turn on the monitor, the monitor cannot recall the programmed custom settings and current time and date. This can occur if the battery is drained or after new software has been installed.

If this occurs, the monitor provides a special sequence of display windows to help you regain use of your monitor as quickly as possible. Do the following:

1. Connect an ac power adapter to recharge the battery (if the battery is drained).

2. Press any button below the equipment alert screen to acknowledge the alert. The monitor will display the Mode Setup window (shown on page 23).
3. Press these buttons to select one of the Factory patient modes for use:

Factory Adult mode **POWERUP*, YES.**

Factory Pediatric mode **NEXT, POWERUP*, YES.**

Factory Neonatal mode **NEXT, NEXT, POWERUP*, YES.**

After you press **YES**, the monitor will display the Time/Day window.

4. Press **NEXT, UP**, and **DOWN** as needed to set the time and date. Then press **ENTER** to store the new time and date.

Note These display screens are only displayed in this order if the PROGRAM FAULT equipment alert occurs.

5. Turn off the monitor, then turn it on again so the settings will take effect.

The monitor is ready for use. If you want to store some customized patient mode program settings, refer to page 23.

If you follow these steps and the equipment alert reappears at powerup, the monitor may need to be serviced and the battery replaced. Contact a qualified service person.

Patient connections

The left side panels differ depending on the Propaq Encore model. All models have ECG, NIBP, and two temperature connectors. The Propaq Encore 204 left side panel includes one invasive-pressure connector, and the Propaq Encore 206 includes two invasive-pressure connectors.

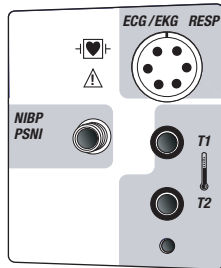

Propaq Encore 202 EL

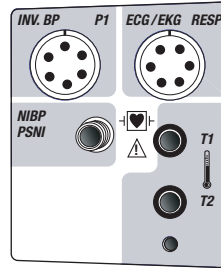

Propaq Encore 204 EL

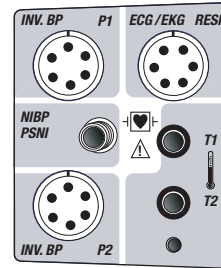

Propaq Encore 206 EL

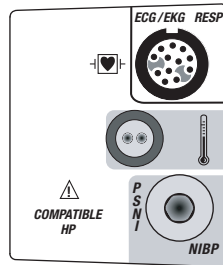

202 HP

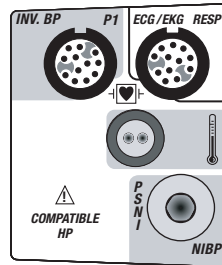

204 HP

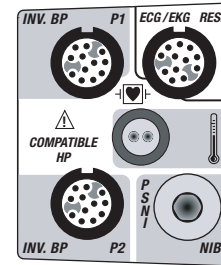

206 HP

On Propaq's with the Hewlett-Packard connector option, all models have only one temperature connector, the YSI 400 connector.

Option connectors

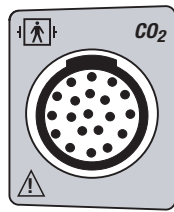

Mainstream CO₂ Connector

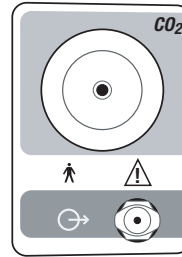

Sidestream CO₂ Connector

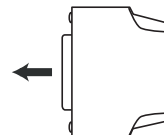

Cable: see the Welch Allyn Products and Accessories guide (810-0409-XX)

Masimo SpO₂ Connector (motion tolerant)

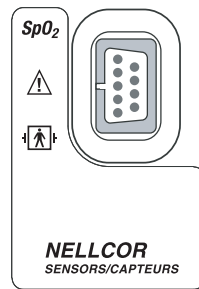

Nellcor SpO₂ Connector

Propaq Encore display

The display shows waveforms, vital sign numeric values, Propaq Encore status, and alarm information in different windows. Different vital sign numeric values (such as heart rate and blood pressures) have upper and lower range limits. If the Propaq Encore detects a vital sign value outside of the Propaq's measurable range, the monitor displays --- (below the range) or + + + (above the range) instead of the vital sign value.



WARNING The Propaq Encore will show + + + for HR numerics between 301-350 beats per minute. Above 350 beats per minute, it may display incorrectly low heart rates, due to intermittent picking of R-waves.

Note Due to differences in software versions and standards required by different countries, the displays shown in this reference guide may be slightly different than the display on your Propaq Encore.

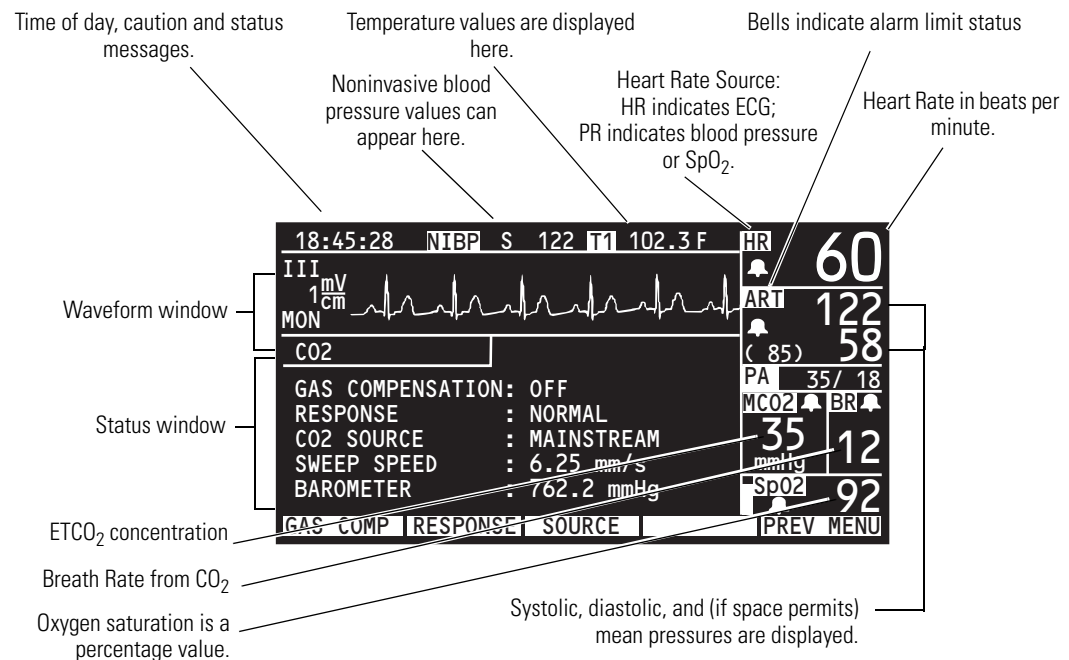

The screenspace is reallocated when vital signs are added or removed. By changing the size of the numeric windows below the heart rate, the Propaq Encore provides the best possible view of all numerics for vitals signs being monitored.

You can select up to three waveforms to be shown on the Propaq. When only one waveform is selected, a trend window automatically appears below the waveform. While changing Propaq Encore settings, a status window may appear below the waveform.

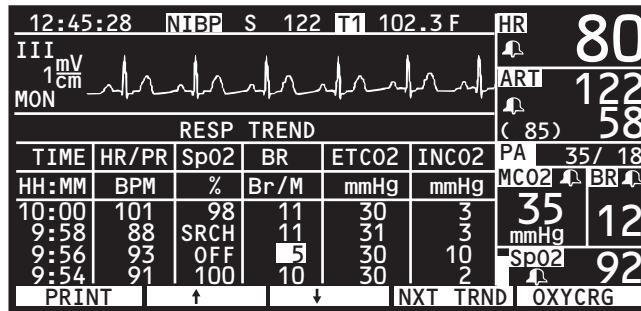

Patient waveform and trend information can be simultaneously displayed, while numeric values are continuously updated.

Propaq Encore buttons

The four buttons at the sides of the screen are reserved for the most commonly used functions.

- ALARMS** Silences or resumes alarm tone.
- START/STOP** Starts and stops NIBP measurements. The STOP function will automatically vent the cuff.
- NET OFF** Disconnects the monitor from the Acuity network (if connected).
- FREEZE/UNFREEZE** Freezes or “unfreezes” the waveforms. If only one or two waveforms are displayed and you press FREEZE, the frozen waveform(s) are shown along with an active waveform so you can continue to monitor the patient’s condition.
- MAIN MENU** Pressing MAIN MENU always returns the monitor to the top level menu.



The five buttons below the screen, and their associated labels located on the screen, provide access to the menus.

Later in this manual, the notation A , B , C is used as a shorter way to say “Press Button A, then B, then C.”

Propaq Encore menus

Menus for some patient vital signs are displayed only if that option is included in your Propaq.

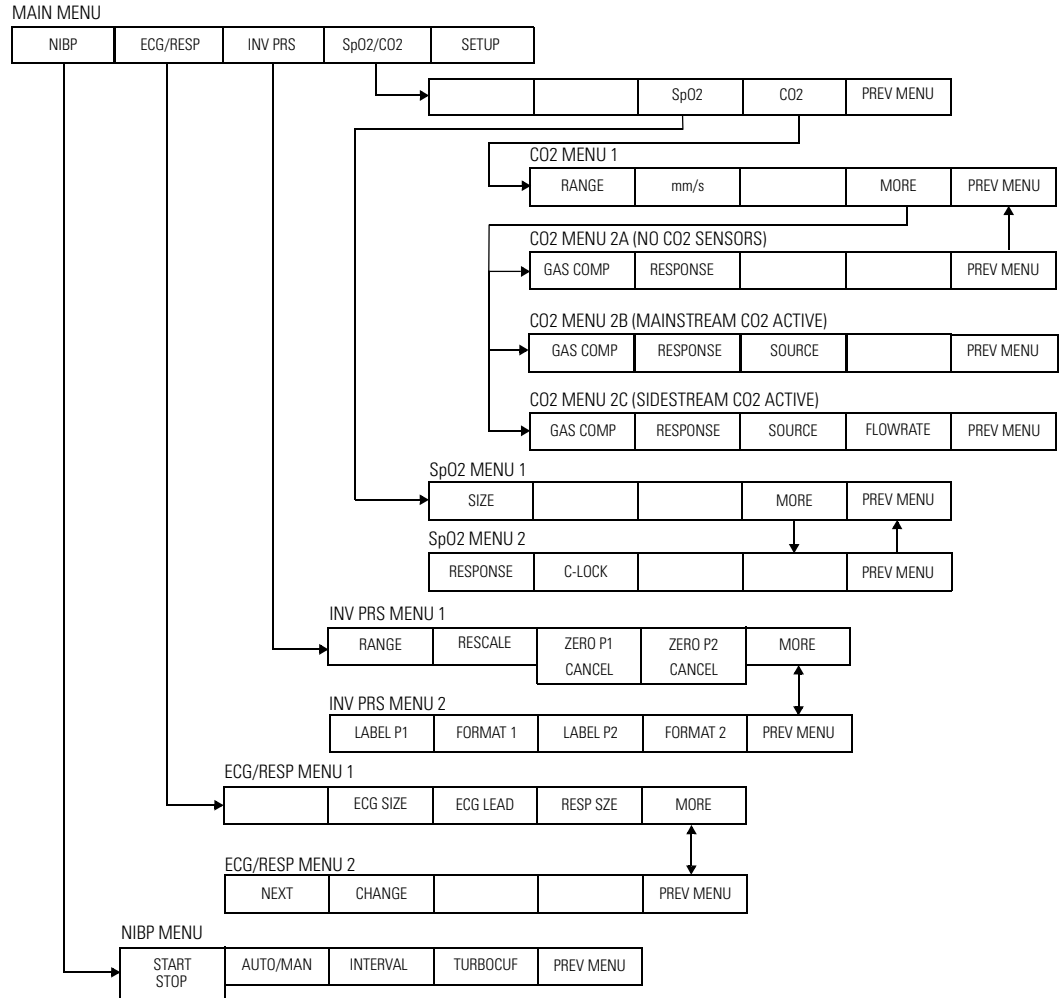

Key-press route to setup menu 1

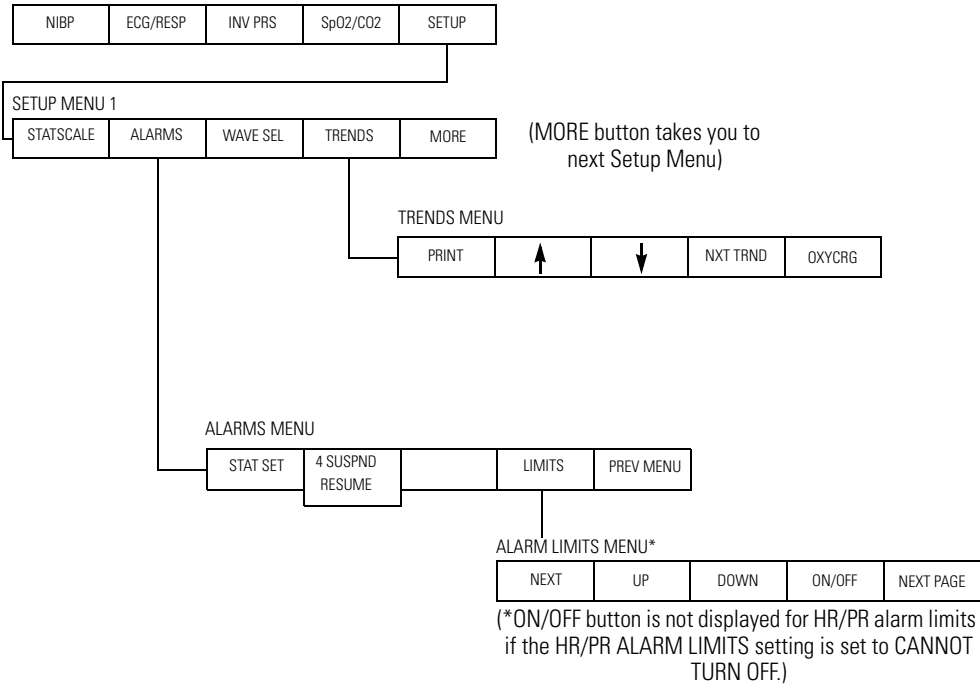

Key-press route to setup menu 2

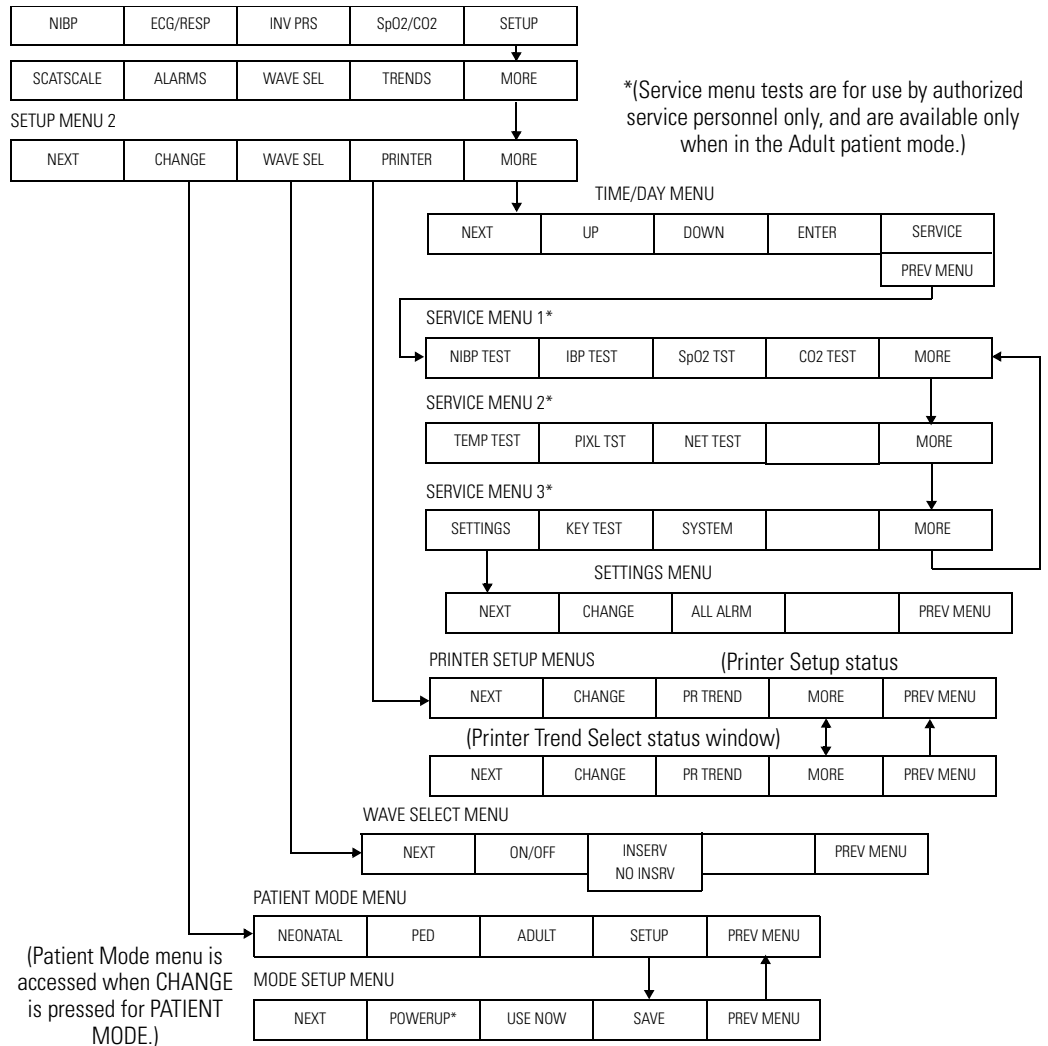

Monitor setup

Setup Menu 1 is accessed by pressing the **SETUP** button on the Main Menu.

STATSCALE | ALARMS | WAVE SEL | TRENDS | MORE

STATSCALE	Automatically readjusts all waveform scales.
ALARMS	Allows access to the Alarms menu.
WAVE SEL	Allows you to turn on and off desired waveforms or NIBP numerics for display.
TRENDS	Allows access to the Trend settings and display.
MORE	Displays the next setup menu and the following status window:

SETUP	HR/PR	RR/BR	(85)	58
CURRENT SOURCE	: ECG	MC02	PA	35/ 18
SELECTED SOURCE	: ART	---	MC02	BR
SWEEP (mm/s)	: 12.5	3.13	35	12
ALARM TONE	: HIGH		mmHg	
HR/PR TONE	: LOW		SpO2	92
PATIENT MODE	: ADULT			
NEXT	CHANGE	WAVE SEL	PRINTER	MORE

NEXT	Selects the next setting in the status window.
CHANGE	Changes the currently selected display setting. (Pressing CHANGE at PATIENT MODE allows you to choose between Adult, Pediatric, and Neonatal in a Patient Mode window.)
PRINTER	Allows access to the Printer Menu.
MORE	Allows access to the Time/Day window.
CURRENT SOURCE	When the selected HR/PR source is no longer available, the current source is the active source with highest priority. The RR/BR source cannot be manually selected. It will always be CO ₂ if CO ₂ is active. Otherwise, it will be ECG/RESP.
SELECTED SOURCE	The user-selected HR/PR source is displayed along with the HR/PR source currently being used by the monitor.
SWEEP (mm/s)	The selectable sweep speeds for HR/PR are 12.5, 25, and 50 mm/sec. The sweep speeds for RR/BR are 3.13, 6.25, and 12.5 mm/sec.
ALARM TONE	Sets the Alarm Tone volume to HIGH, MEDIUM, or LOW.

HR/PR TONE Sets the Heart Tone volume to HIGH, MEDIUM, LOW, or OFF.

PATIENT MODE Pressing CHANGE in this selection displays the following Patient Mode window:

PATIENT MODE		BATTERY: 9.2 VOLTS		(85)	58
SELECT PATIENT MODE BASED ON AGE:				PA	35 / 18
NEO : < 44 WEEKS GEST. AGE				MC02	BR
PED : > 44 WEEKS GEST. AGE,				35	12
< 9 YEARS				mmHg	
ADULT: > 9 YEARS				SpO2	92
NEONATAL	PED	ADULT	SETUP	PREV MENU	

If you press NEONATAL, PED, or ADULT, a confirmation window appears, requiring you to confirm your selection:

PATIENT MODE		CHANGING SETTINGS AND MODE TO:		(85)	58
CUSTOM: ADULT				PA	35 / 18
ADULT ALARM LIMITS WILL BE SET				MC02	BR
ARE YOU SURE?				35	12
				mmHg	
				SpO2	92
YES		NO			

Note

Whenever you change the patient mode, the alarm limit settings are automatically changed to the defaults for that mode. If Custom settings have been set for that mode, the defaults are the Custom mode settings. If no Custom settings have been set, the defaults are the Factory Mode settings. See page 23 for more information about patient modes.

If you change the patient mode, the CO₂ alarm limits in the new mode might vary slightly from the originally-programmed CO₂ limits for the new mode. Check the CO₂ alarm limits.

If you press SETUP in the previous Patient Mode window, the Mode Setup window appears. This allows you to set custom patient modes and powerup defaults as described on page 23.

Selecting waveforms for display

To select waveforms for display, press **SETUP, WAVE SEL**. Use the **NEXT** and **ON/OFF** buttons to turn on the desired waveforms in the wave select window:

SETUP	WAVE SELECT	(85) 58
ECG : ON	RESP : OFF	PA 35/ 18
ART : ON	SpO2 : ON	MC02 BR
PA : OFF	NIBP : ON	35 mmHg 12
CO2 : OFF		SpO2 92
NEXT	ON/OFF	INSERV
		PREV MENU

Display priorities

You can turn on more than three waveforms, but only the first three waveforms listed in the wave select window that are monitored are displayed. The patient parameters being monitored are listed in the order they will be displayed if all are turned on.

Because of the critical nature of the ECG waveform, you cannot turn off ECG. However, if ECG is not monitored, another waveform will occupy its place.

The displayed waveforms are also the ones printed if a printer is attached.

Setting the time and date

To set the time and date, from the Main Menu press **SETUP, MORE, MORE**. The monitor displays the Time/Day window:

TIME/DAY	BATTERY: 9.2 VOLTS	(85) 58
<u>TIME</u>	<u>DAY</u>	PA 35/ 18
H:MIN:S	MO/DA/YR	MC02 BR
07:45:32	06/12/97	35 mmHg 12
		SpO2 92
NEXT	UP	DOWN
		ENTER
		PREV MENU

Press **NEXT**, **UP**, and **DOWN** as needed to set the time and date. Then press **ENTER** to store the new time and date.

Time/day settings and trends



WARNING Changing the hour/minute/second setting for the monitor in the Time/Day window can cause the monitor to erase previously stored patient trend data.

When you change the hour/minute/second setting for the monitor in the Time/Day window, the monitor deletes any patient trend data that is older than five hours for non-NIBP trends or older than eight hours for NIBP trends according to the new clock setting.

However, if the monitor has not yet stored the full capacity of trends and you change the hour/minute/second setting to a time that is within the stored trend period, previously stored trends are not erased.

Changing the day, month, or year setting does not affect the stored patient trends.

Changing the date format, filter, and units

To change the date format, ECG filter, or some measurement units, first make sure you are in the Adult patient mode. Then press **SETUP, MORE, MORE, SERVICE, YES** (to access the Service Menu), **MORE, MORE, SETTINGS**. The monitor displays the Settings window:

SETTINGS	BATTERY: 9.2 VOLTS	(85)	58
DATE	: MO/DA/YR	PA	35/ 18
FILTER	: 60 Hz	MC02	BR
TEMP F/C	: C	35	12
DECIMAL	: .	mmHg	
HR/PR ALARM LIMITS:	CAN TURN OFF	SpO2	92
CO2 UNITS:	mmHg		
NEXT	CHANGE		PREV MENU

NEXT	Selects the next setting in the status window.
CHANGE	Changes the currently selected display setting.
DATE	Sets the date format: Month/Day/Year, Day.Month.Year, or Year/Month/Day.
FILTER	Sets the ECG filter frequency. Make sure it is set to your ac mains frequency.
TEMP F/C	Sets the temperature display units: either degrees Fahrenheit or Celsius. If you change the units, the TEMP trends will not be cleared.
DECIMAL	Sets the decimal character as either a period (.) or a comma (,).
HR/PR ALARM LIMITS	Allows or prohibits turning off the HR/PR alarm limits. If CANNOT TURN OFF is selected, the ON/OFF button is not displayed on the HR/PR Alarm Limits Menu.
CO ₂ UNITS	Sets the CO ₂ display units as mmHg, kPa, or percent (%). If you change the units, the CO ₂ trends will be cleared and CO ₂ alarm limit settings change to the factory default settings for the currently-used patient mode.

Note Any time you change the Date, Filter, Temp F/C, Decimal, HR/PR Alarm Limits (CAN or CANNOT TURN OFF) or CO₂ Units setting, the new setting also becomes the powerup default setting.

Setting the current, custom, and power-up modes

The Propaq Encore has two sets of patient mode settings:

- Factory patient modes. The powerup settings and alarm limits for these patient modes are preset and cannot be changed. They are listed in ["Factory default settings"](#) on page 118.
- Custom patient modes. You can customize the power-up settings and alarm limits for these patient modes. (See **SAVE** on page 24.)



WARNING If any alarms are set to OFF and you select SAVE to store the settings for that CUSTOM patient mode, those alarms will be OFF whenever the Propaq powers up in that CUSTOM patient mode or when that CUSTOM patient mode is selected. Consider carefully before setting CUSTOM patient mode powerup alarms to OFF.

Note The alarm for apnea cannot be turned off at any time.

You can program the Propaq Encore to power up in any of the Factory patient modes or the Custom patient modes. You can also change the current patient mode during operation.

Note Whenever you change the patient mode, the alarm limit settings automatically change to the settings for that mode.

From the Main Menu, press **SETUP, MORE, CHANGE, SETUP**. The Mode Setup window appears:

MODE SETUP		BATTERY: 9.3 VOLTS		ZEROED	
FACTORY:	*ADULT	PED	NEO	P2	NO ZERO
CUSTOM :	ADULT	PED	NEO	MC02	BR
* = PATIENT MODE ON POWERUP				38	12
				mmHg	
				SpO2	97
NEXT	POWERUP*	USE NOW	SAVE	PREV	MENU

The asterisk (*) indicates which patient mode is currently selected for powerup.

- NEXT** Selects the next setting in the status window.
- POWERUP*** Selects the highlighted patient mode (and its associated settings) as the powerup mode. The selected powerup mode is marked by an asterisk (*). (This does not change the current patient mode.)
- USE NOW** Selects the highlighted patient mode (and its associated settings) as the current patient mode. (This does not affect the powerup mode.)
- SAVE** Use this button to reprogram the settings of Custom patient mode:
1. Make sure the patient mode you want to reprogram (ADULT, PED or NEO) is currently used. (To change patient modes, highlight the desired mode and press USE NOW, YES.)
 2. Exit the Mode Setup window, then use other menus and buttons to set the monitor settings and alarm limits as desired.
 3. Re-enter the Mode Setup window, highlight the desired Custom mode, and press SAVE, YES.

Printer functions

Press **SETUP, MORE, PRINTER** to display the printer menu and setup window.

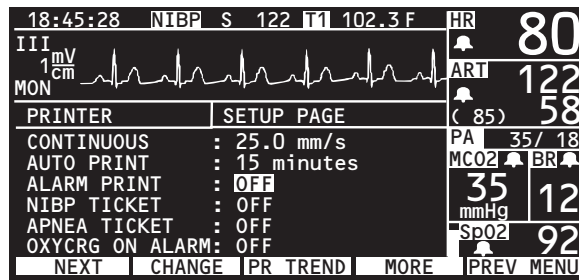

NEXT	Selects the next setting in the status window.
CHANGE	Changes the currently selected display setting.
PR TREND	Prints all trends turned on in the Printer Trend Select Window.
MORE	Pressing the MORE button displays another menu and status window.
PREV MENU	Returns you to the previous menu.
CONTINUOUS	Sets the print speed for real time (continuous) measurements to 6.25, 12.5, or 25 mm/sec. This sets the print speed for a printout obtained by pressing the START/STOP button on the printer.
AUTO PRINT	Automatically prints 8 seconds of patient information every 15 minutes, 30 minutes, 1 hour, 2 hours, or 4 hours. This is the latest patient information (real time). The print speed is automatically set to 25 mm/sec.
ALARM PRINT	Automatically prints upon an alarm. The Propaq Encore prints 20 seconds of patient information. The first 12 seconds contain information prior to the alarm. The print speed is automatically set to 25 mm/sec.
NIBP TICKET	Automatically prints an NIBP Ticket when the measurement is taken.
APNEA TICKET	When turned on, an Apnea Ticket is printed at the conclusion of an apnea alarm and at the one-minute clock interval if the apnea alarm does not cease.
OXYCRG ON ALARM	When turned on, an oxycardiogram will print if an HR/PR, SpO ₂ , or RR/BR alarm occurs. For more information on OxyCRG, see "OxyCRG" on page 82.

PRINTER FAULT messages

These PRINTER FAULT messages can appear in an equipment alert window.

LOW BATTERY, PRINTER DISABLED	This message appears when the Propaq's battery voltage is less than 7.6 volts. To continue operation, plug the ac power adapter into the Propaq.
CHECK DOOR	The door on the bottom of the printer is open. Close door to remove this message.
PAPER OUT	To add printer paper, see " Printer maintenance " on page 96.
OVERHEATING	The printer is overheating. Service may be required.

The front panel of the printer lets you control the basic printer functions.

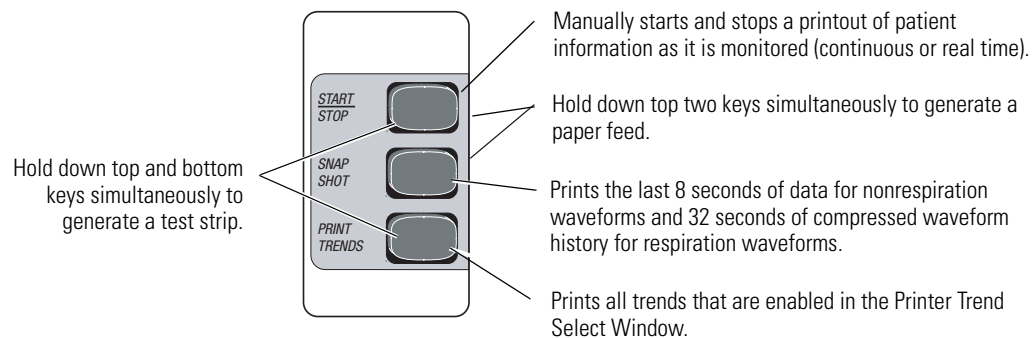

If you press FREEZE prior to pressing SNAPSHOT, the printer prints the 8 seconds of patient information obtained prior to when you pressed FREEZE.

Learning the Propaq Encore

Using in-service mode

You can practice using the Propaq Encore without a patient simulator by using the Propaq's in-service mode of operation. The in-service mode cannot be activated while you are monitoring a patient. The message "SIMULATING" alternates with the time of day and patient mode on the display.

To begin practicing with your Propaq, disconnect all patient cables connected to the monitor. Leave the cuff connected so you can take NIBP measurements. If you have been monitoring a patient, turn off the Propaq Encore and turn it back on. From the Main Menu, press **SETUP, WAVE SEL, INSERV**.

The Propaq Encore has two sets of simulated patient information—an initial set and an alternate set. To change between them, press the **INSERV** button again.

If you connect a patient cable or set the NIBP channel to automatically take pressure measurements, the Propaq Encore stops simulating, goes through its powerup tests, and erases any simulated trend data it might have stored.

What you can do with in-service mode

While using the in-service mode, you can press any of the Propaq Encore buttons, except for the **AUTO/MAN** button in the NIBP Menu, to change a function setting. You can also:

- change the ECG and RESP waveform sizes
- set alarm limits and cancel alarms
- STAT SET alarms
- customize the Propaq Encore settings
- change from °F to °C
- simulate invasive-pressure zeroing

NIBP

For noninvasive pressure measurements, keep the Propaq Encore in manual NIBP operating mode and take pressure measurements by pressing the **START** button. You can also press the NIBP Menu's **TURBOCUF** button to consecutively take pressure measurements for five minutes.

Printer message

Simulated data can be printed on the Propaq Encore Printer. All printouts include the message "SIMULATED DATA" every four inches to prevent simulated data from being mistaken for actual patient data.

What you cannot do with in-service mode

- You cannot use in-service mode to calibrate the monitor.
- You cannot set the Propaq Encore to take automatic noninvasive pressure measurements (except Turbocuf) while using in-service mode.
- You cannot use Defib Sync or Real-time ECG output while using in-service mode.
- You cannot activate in-service mode if you have been monitoring a patient.

Confirm and learn alarm behavior in the in-service mode



To confirm that a Propaq monitor is properly generating patient alarms and to learn the alarm behavior of the Propaq Encore monitor, perform the following steps.

1. Disconnect all patient cables from the Propaq monitor.
2. To temporarily remove customized alarm settings, press the **MAIN MENU** key, then **SETUP, MORE, CHANGE, SETUP, USE NOW, YES**.
3. To put the Propaq monitor in (non-alarming) Inservice Mode 1, press **MAIN MENU, SETUP, WAVE SEL, INSERV**.
4. To set the Propaq monitor in (alarming) Inservice Mode 2, press **MAIN MENU, SETUP, WAVE SEL, INSERV**.

Within 3-5 seconds, the monitor will alarm because the "patient's" vital signs fall outside of the alarm limit ranges.

5. Confirm the following:

The monitor is sounding an alarm
A vital sign numeric is flashing
The small red light in the top right corner of the monitor is flashing
The SILENCE and LIMITS keys are showing on the screen

6. To silence the alarm tone for 90 seconds, press / or **SILENCE**.

Visual alarm indications remain, and the alarm tone resets after the 90-second silence period.

7. To bring the Propaq monitor back into the (non-alarming) Inservice Mode 1, press **INSERV**.

The “patient’s” vital sign readings will return to acceptable levels within the alarm limit range.

8. Turn off the Propaq monitor.

Any previously set custom patient mode settings are restored when you turn it on again.

Under these conditions, if the monitor fails to generate visual or auditory alarm indications, carefully repeat the above steps. If the monitor is still unresponsive, remove it from circulation and take it to your facility’s biomedical service department for evaluation.

3

Patient monitoring

ECG/RESP

Intended use—impedance pneumography (RESP)

The Respiration channel is intended to detect the rate or absence of respiratory effort, deriving the signal by measuring the AC impedance between the selected terminals of the ECG electrodes. RESP displays a respiration rate and waveforms. Two respiration lead selections are available, Lead 1 (RA-LA) and Lead 2 (RA-LL).



WARNING Impedance pneumography detects respiratory effort via changes in chest volume; therefore, impedance pneumography can be used to detect central apnea. However, apnea episodes with continued respiratory effort, such as obstructive apnea and mixed apnea, may go undetected. Always monitor and set alarms for SpO₂ when using impedance pneumography to monitor respiratory function.

WARNING With any monitor that detects respiratory effort via impedance pneumography, artifact due to patient motion, apnea mattress shaking, or electrocautery use may cause apnea episodes to go undetected. Always monitor and set alarms for SpO₂ when using impedance pneumography to monitor respiratory function.

WARNING The Propaq Encore automatically rejects cardiovascular artifact (CVA). This function is dependent upon accurate ECG R-wave detection. Therefore, always select the ECG lead with the most prominent QRS complex when monitoring respiration via impedance pneumography.

WARNING Don't place the Propaq Encore monitor with RESP in close proximity with another respiration monitor because the RESP measurement frequencies may interfere with one another.

WARNING Because pacemaker pulses in some instances may be falsely counted as breaths, impedance pneumography is not recommended for use on paced patients.

Note Impedance pneumography is not recommended for use with high frequency ventilation.

Since RESP is derived from the same leads as the ECG channel, the Propaq Encore determines which signals are cardiovascular artifact and which signals are a result of respiratory effort. If the breath rate is within five percent of the heart rate or a multiple or sub-multiple of the heart rate, the monitor may ignore breaths and trigger an apnea alarm.

Intended use—ECG

The Propaq Encore is intended for ECG monitoring of either a five-lead or three-lead configuration, including the Marriott configuration 1 (MCL1 requires all three electrodes). The five lead configuration can derive one of seven user-selected signals, Lead I, II, III, aVR, aVL, aVF, or V.

The monitor will automatically determine if only three lead wires are connected, and will automatically reduce the number of selectable leads to three (I, II, III). If four-wire ECG cables are used, they will be handled as if they were three-wire cables.



WARNING The Propaq Encore monitor does not have automated arrhythmia analysis, therefore, some ventricular tachycardias and ventricular fibrillation may not be interpreted correctly and may display an inaccurate heart rate.

The Propaq Encore 200 series does not have automated ST segment monitoring, although with ECG set for extended bandwidth, ST segments may be accurately displayed and printed.

The Propaq Encore ECG's bandwidth is 0.5-40 Hz in Monitor Mode and 0.05-40 Hz in Extended Mode. Monitor Mode is useful to minimize baseline wander due to respiration or other artifact. However, in Monitor Mode, ST segments can be distorted, potentially causing underestimation of ST elevation and overestimation of ST depression. Always use Extended Mode when observing ST segment morphology on the display or printer.

The Propaq Encore can be used during procedures using electrosurgical machines and defibrillators. However, even though the ECG channel contains electrosurgical interference suppression (ESIS) circuitry, noise artifact may be displayed on the ECG trace while an electrosurgical device is in use. This will vary depending on ECG electrode placement and the operative site.



WARNING High-intensity radio frequency (RF) energy from external sources, such as an improperly connected electrosurgical unit, can induce heat into electrodes and cables which can cause burns on the patient. Reading errors and damage to equipment may also result. This hazard can be reduced by (1) avoiding the use of small ECG electrodes, (2) selecting ECG electrode attachment points remote from the surgical site and from the electrosurgical return electrode, (3) using electrosurgical return electrodes with the largest practical contact area, and (4) assuring proper application of the electrosurgical return electrode to the patient.

WARNING Verify patient mode. Incorrect patient mode may result in inaccurate heart rates and inappropriate alarm settings.

Even though the Propaq Encore contains fully isolated patient-connected circuitry, it has not been specially designed for direct cardiac application.

The Propaq Encore can be used on patients with pacemakers. See [“Using the Propaq Encore with pacemaker patients”](#) on page 35.

ECG connector and applicable accessories

Use only with accessories provided or recommended by Welch Allyn. Refer to the Welch Allyn *Products and Accessories* guide.

To prevent injury, use the provided garment clips to route the ECG cables away from the patient's head.



WARNING Use of ECG cables with loose or faulty detachable lead wires may cause erratic behavior of the ECG waveform, SpO₂, C-Lock, and NIBP due to intermittent ECG lead wire connections.



Caution To protect the Propaq Encore from damage during defibrillation, for accurate ECG information, and for protection against noise and other interference, use only ECG electrodes and cables (namely, ones with internal current-limiting resistors) specified or supplied by Welch Allyn, and follow recommended application procedures.

Preparation



WARNING Use only ECG safety cables that are designed so that they cannot accidentally be plugged into an AC mains outlet or make contact with other hazardous electrical potentials including earth ground. To prevent damage during defibrillation, don't use ECG cables without 1K series resistors.

Preparing for ECG monitoring with the Propaq Encore requires you to prepare the monitor, prepare the patient, set up the ECG channel, and then set the ECG alarms.

Preparing the monitor

1. Inspect the ECG cable for wear, breakage, or fraying. Replace the cable if it shows signs of any of these. Plug the ECG cable into the ECG connector on the Propaq's left side panel.



WARNING Before you use a Propaq on a new patient, always turn it off for a few seconds, then turn it on again. This clears the prior patient's trend values, alarm limit settings, and NIBP cuff inflation target.

2. If the monitor is off, press the OFF/ON switch to turn it on.
3. Select the patient mode appropriate for the patient (Neonatal, Pediatric, Adult). To change patient modes, see "[Monitor setup](#)" on page 20.

Preparing the patient

1. Thoroughly clean the skin areas where the electrodes will be attached. Attach lead wires to the electrodes before applying them to the patient.
2. If you are using pre-gelled electrodes, use only electrodes that have not expired. Make sure there is a generous amount of gel in the electrode and that it has not dried. For best results, use silver/silver chloride electrodes.
3. If you are using non-gelled electrodes, apply a 1/4 to 1/2 inch mound of gel over the electrode contact area.

Note Some electrodes may be subject to large offset potentials due to polarization. This effect is most likely when dissimilar metals are used for different electrodes, and may be severe enough to prevent obtaining an ECG trace. Furthermore, recovery time after application of defibrillator pulses may be compromised when using electrodes of dissimilar metals. Squeeze bulb electrodes, even if all of the same metal, are particularly vulnerable to this effect. Stainless steel needle electrodes are prone to having large erratic offset drifts, and are not recommended.

4. Apply the electrodes to the patient.

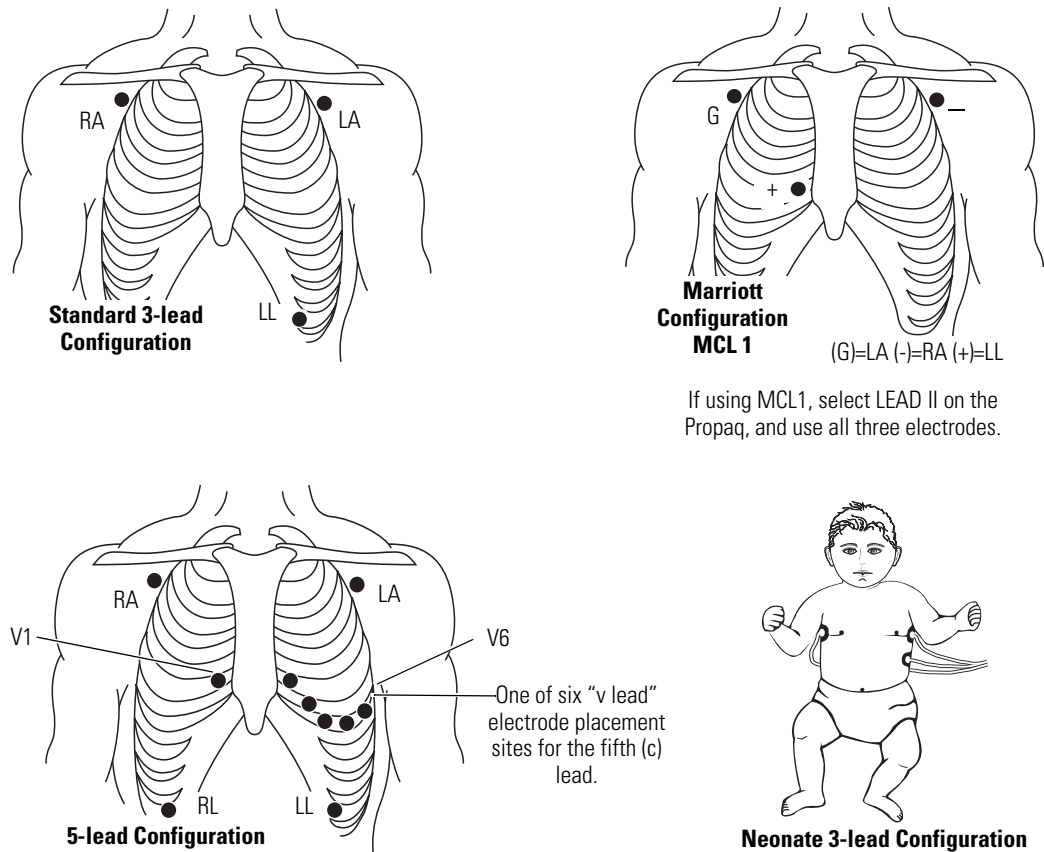

5. Support the ECG cable so it does not stress the electrode wires, ECG cable connectors, or electrodes.

Note Two RESP leads are available. Choose the one that gives you the best signal. If neither signal is adequate, it may be necessary to experiment with nonstandard electrode placement such as placing the RA and LA electrodes on the respective mid-axillary lines just above the level of the nipples.

6. If an electrosurgical unit is going to be used, place the ECG cable and electrode wires as far as possible from the surgical site and from the electrosurgical return electrode and its cables. This will minimize interference.

By now there should be some kind of ECG waveform displayed on the monitor. A heart rate should be displayed to the right of the waveform. Depending on how the Propaq Encore is programmed, a beep tone may occur with each detected QRS event.

7. If there is no waveform, check the electrodes, wires, cable, and the monitor for a possible lead fault.

If an ECG electrode becomes disconnected or disrupted so that the Propaq Encore cannot receive the ECG signal, a message and tone are conveyed with an equipment alert.

Setting up the ECG/RESP channel

Press **ECG** or **ECG/RESP** (available with the Impedance Pneumography Option) to set the selections: ECG SIZE, ECG LEAD, RESP SZE (available with Impedance Pneumography). The **MORE** button displays the second ECG/RESP menu and a status window with selections for HR/PR TONE, PACER DISPLAY, ECG BANDWIDTH, and RESP LEAD (available with Impedance Pneumography). If the patient being monitored has a pacemaker, you may want to turn on the Pacer indicator function.

Setting ECG/RESP alarms

Set the alarm limits according to your hospital's standards.

Motion artifact or other factors can cause false HR/PR alarms. To help minimize false alarms, the Propaq delays or "holds off" triggering an HR/PR alarm for 3 seconds. During this holdoff period, if the Propaq detects that the patient's HR/PR vital sign has returned to acceptable limits, the Propaq cancels the alarm holdoff. The next time an HR/PR limit is violated, the Propaq starts a new 3-second HR/PR alarm holdoff period.

How ECG/RESP is displayed

Because of the critical nature of monitoring ECG, it is always displayed in the top part of the waveform display area. The ECG waveform is the only waveform that cannot be turned off using the Setup Wave Select Menu.

Respiration rate numerics are sourced from the CO₂ channel and displayed as BR when CO₂ is active. Otherwise, respiration rate numerics are sourced from the ECG/RESP channel and displayed as RR.

Patient artifact

Patient movement and other artifact might cause the waveform to move on the display. Most artifact such as this is automatically detected, and the waveform is adjusted so that it always remains centered in the waveform window.

Severe artifact and interference (such as interference from defibrillation) may cause the waveform to move off the display. The Propaq Encore will always automatically reposition the waveform in just a few seconds so you can see it again.

ECG/RESP menus and status window

	ECG SIZE	ECG LEAD	RESP SZE	MORE
--	-----------------	-----------------	-----------------	-------------

ECG SIZE Selects the ECG waveform size; sizes are shown in millivolts per centimeter (.2, .5, 1, 2, or 4 mV/cm) to the left of the waveform.

ECG LEAD Selects the ECG lead. The available leads are lead I, II, III, aVR, aVL, aVF, or V. The Propaq's factory default lead setting is Lead II.

Impedance pneumography selections

If your Propaq Encore includes the Impedance Pneumography Option, the following selection is also available:

RESP SIZE Selects the RESP waveform size.

The Size function “increases” and “decreases” the ECG or RESP waveform size. Each time you press a **SIZE** button, the waveform approximately doubles in height. When you reach the largest waveform size, the next press displays the smallest size.

When you press MORE in the first ECG/RESP Menu, a status window appears showing you the current ECG/RESP settings and additional selections.

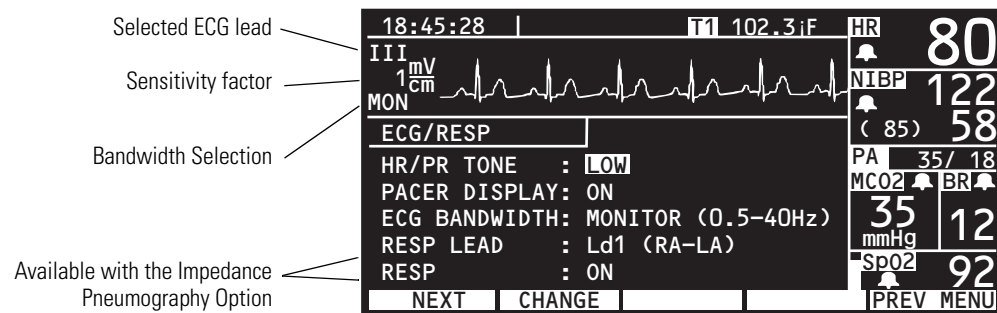

HR/PR TONE Sets the heart tone loudness to LOW, MEDIUM, HIGH, or OFF. If SpO₂ is monitored, the pitch of the tone varies with the SpO₂ value.

PACER DISPLAY Turns on and off the pacer indicator in the ECG waveform.

ECG BANDWIDTH This selection allows you to determine the bandwidth for the data sent to the display and the printer. If the selection is Extended, the bandwidth is 0.05-40 Hz. If the selection is Monitor, the bandwidth is 0.5-40 Hz.

The Size function “increases” or “decreases” the ECG or RESP waveform size. Each time you press a SIZE button, the waveform approximately doubles in height. When you reach the largest waveform size, the next press displays the smallest size.

Note The QRS detector sensitivity threshold is not affected by changing the ECG display size. Likewise, the RESP breath detector threshold is not affected by changing the RESP display size.

RESP LEAD Selects the RESP lead. Choices are RA-LA and RA-LL, and choice is independent of ECG lead selection. Experiment with placement for best signals.

RESP Turns impedance pneumography (RESP channel) on or off.

Note The Propaq Encore counts as “breaths” respiratory efforts that are larger than two times background Cardiovascular Artifact (CVA).

Since RESP is derived from the same leads as the ECG channel, the Propaq Encore determines which signals are cardiovascular artifact and which signals are a result of respiratory effort. If the breath rate is within five percent of the heart rate or a multiple or sub-multiple of the heart rate, the monitor may ignore breaths and trigger an apnea alarm.

Using the Propaq Encore with pacemaker patients



WARNING Pacemaker signals can differ from one pacemaker to the next. The Association for Advancement of Medical Instrumentation (AAMI) cautions that “in some devices, rate meters may continue to count the pacemaker rate during occurrences of cardiac arrest or some arrhythmias. Do not rely entirely upon rate meter alarms. All pacemaker patients should be kept under close or constant observation.”

Pacemaker signals

If the patient being monitored has a pacemaker, the Propaq Encore detects and can indicate the occurrence of pacemaker signals. With the Propaq, pacemaker signals are not counted as heart beats as long as the pacemaker signal meets the pulse amplitude, pulse width, and overshoot/undershoot specifications listed in Appendix B.

Pacer display

On the Propaq Encore display, vertical dashed lines indicate each time a pacemaker signal is detected when the Propaq Encore PACER function is turned on. The waveform “spike” produced by the pacemaker will also be displayed if it contains sufficient energy. Whether the pacer is atrial, ventricular, or both, the indicator and the spike appear. If the PACER function is turned off, only the pacemaker spike is displayed:

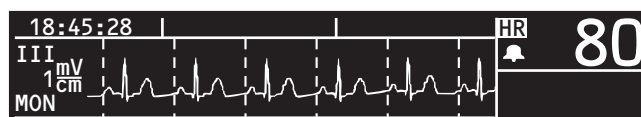

Turn the pacemaker indicator on and off

The status of the pacer display is shown in the ECG status window. Turn PACER DISPLAY on or off using the NEXT and CHANGE buttons.

Noise on the signal

Noise on the ECG signal may be detected as pacer signals, causing the pacer indicator to appear on the display. If you don't need to indicate pacemaker signals, you may want to turn off the pacemaker indicator for a better display of the ECG waveform.



WARNING The presence of much pacer-like noise can cause the displayed heart rate to be erratic even though the ECG trace may look clean with the pacer indicator off. Fix the noise problem by using fresh ECG electrodes and an ECG cable whose lead wires make good connections.

Using the filter to better display a waveform

The Propaq Encore includes a filter that reduces noise from the ac power signal and produces a much clearer ECG waveform. To set the filter, press **SETUP, MORE, MORE, SERVICE, YES** (to access the Service Menu), **MORE, MORE, SETTINGS** to display the Settings Menu. Select the FILTER function with the **NEXT** button and press the **CHANGE** button to change settings.

Set the filter to the ac mains frequency of your hospital (either 60 or 50 Hz).

Simultaneous equipment alerts

MULTIPLE. If multiple equipment alerts occur simultaneously, the Propaq monitor displays this message. In this situation, the source of the alert may not be displayed (resulting in the message **MULTIPLE**). Look for blank numeric or waveform areas on the display, or status messages at the top of the display to identify the source(s) of multiple alerts.

Note The monitor can also display **MULTIPLE LEAD FAIL** if, for example, there is a problem with an ECG lead and RESP lead at the same time. In this case, the monitor will alternately display **ECG FAULT** and **RESP FAULT**. Check all ECG and RESP leads for proper connection and operation.

ECG messages

ECG FAULT. (This message is displayed in the status message area at the top of the display.) A problem occurred with ECG. If the problem is caused by a defective or disconnected lead, the monitor typically displays an additional message that indicates which lead failed (such as LL LEAD FAILED). Check the ECG lead for proper connection and operation.

ECG LEAD CHANGED. The Propaq monitor has automatically changed an ECG lead due to a lead wire or electrode problem.

LEAD FAIL: REPLACE ELECTRODES. The cable may not be properly connected to the electrodes or the electrodes may have failed. Check for proper connection; replace electrodes if needed.

MULTIPLE LEAD FAIL. The monitor displays this message if multiple ECG leads fail. Check all ECG leads for proper connection and operation.

RESP messages

RESP FAULT. (This message is displayed in the status message area at the top of the display.) A problem occurred with RESP. The monitor typically displays an additional message indicating the cause of the problem, such as a problem with a RESP lead. Check for proper connection; replace electrodes if needed.

LEAD FAIL. One or more electrodes are making very poor or no contact. Check for proper connection; replace electrodes if needed.

INAPPROPRIATE ECG CABLE. ECG cable appears not to contain 1 kW current limiting resistors. These resistors are required for RESP operation and to protect the monitor from damage during defibrillation. Replace cable with proper type.

NOISY SIGNAL, CHECK ELECTRODES. Electrodes are making poor contact and may be dried out. Replace electrodes.



WARNING If a disconnected lead is in too close proximity to other electrical devices, it may cause false heart rate, a failure to detect apnea, or a failure to display a Lead Fail message.

Invasive pressure

This section applies only to Propaq Encore Models 204EL and 206EL. If you don't have one of these models, you can skip this section.

Intended use

The Propaq Encore invasive pressure channel is intended for measuring arterial, venous, and intracranial pressures using invasive transducers with 5 $\mu\text{V}/\text{V}/\text{mmHg}$ sensitivity. The Propaq Encore can be used with many types of transducers, including nondisposable, disposable dome, and fully disposable.

Invasive pressure connectors and transducers

Recommended transducers for use with the Propaq Encore are listed in the Welch Allyn *Products and Accessories* guide. Do not use light-sensitive disposable transducers. Transducers must be used according to your hospital's standards and the manufacturer's recommendations. Always refer to the manufacturer's Directions for Use before using the transducer.



WARNING If electrocautery is used, always avoid using any transducer with a conductive (metal) case that is electrically connected to its cable shield. Using a conductive transducer case with such a shield connection risks high-frequency burns at the ECG electrodes if the transducer case becomes earth grounded.



WARNING Although complete disconnections of invasive pressure transducers will be detected by the normal alarm functions, partial disconnection will not be detected, nor will the use of some incompatible transducers. The user must exercise reasonable measures to ensure that approved transducers are used and that pressure transducers are connected properly.

WARNING Before you use a Propaq on a new patient, always turn it off for a few seconds, then turn it on again. This clears the prior patient's trend values, alarm limit settings, and NIBP cuff inflation target.

Preparation

Preparing for invasive pressure monitoring with the Propaq Encore requires you to prepare the transducer, zero the transducer, set up the pressure channel, and set the invasive pressure alarm limits.

Preparing the transducer

1. Inspect the transducer cable for wear, breakage, or fraying. Replace it if the cable shows signs of any of these. Replace the transducer dome if necessary.
2. Apply the transducer according to your hospital's procedures. Always refer to the transducer manufacturer's Directions for Use.
3. If the transducer is a disposable unit with separate cable, connect the transducer to the transducer cable. Plug the transducer cable into an invasive pressure connector on the left side panel.

The message NOT ZEROED (or NO ZERO, depending on the zone) immediately appears in the blood pressure numerics window for the invasive pressure channel being used.

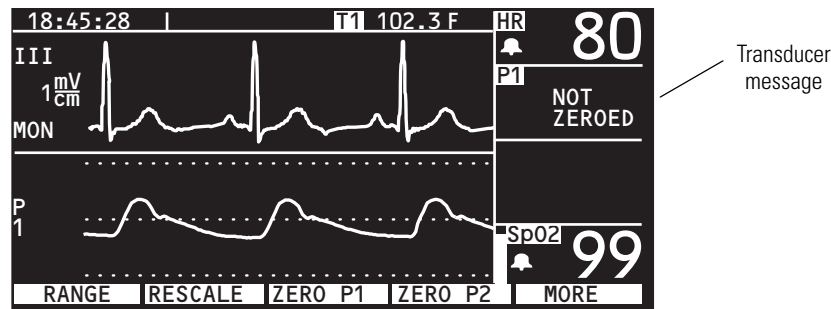

Zeroing the transducer

1. To zero the transducer, open the transducer's stopcock to atmospheric air. Allow a few seconds for the transducer to settle.
2. If the ZERO menu is not displayed, press the following Propaq Encore buttons: **INV PRS**, then **ZERO P1** (or **ZERO P2**). The word ZEROING appears in the numerics window during zeroing. The button label changes to CANCEL to allow you to cancel the zeroing process if necessary.
3. Wait for a tone to briefly sound and the word ZEROED to appear in the blood pressure numerics window. You will then see the pressure scale to the left of the waveform, and the pressure numerics appear.
4. Close the transducer's stopcock.
5. If the transducer will not zero, the words ZERO REJECTED (or NO ZERO, depending on zone) will appear in the numerics window. Press **CANCEL** and try zeroing again. You won't see the pressure values and the scales until an acceptable zero reference is established.
6. Check that the transducer is open to atmospheric air and that it is properly connected to the Propaq Encore, then try zeroing again. The Propaq Encore will not allow zeroing to occur if the pressure waveform is pulsatile, if there is too much noise in the signal.

or if the transducer's offset is too great. Once the channel is zeroed, the pressure scale appears next to the waveform.

If the transducer still does not zero, try another transducer or another cable.

Setting up the pressure channel

Press **INV PRS** to set the invasive pressure channel selections: RANGE, RESCALE, and ZERO P1/ZERO P2. Press **MORE** to set LABEL P1/LABEL P2 and FORMAT 1/FORMAT 2.

Setting the invasive pressure alarms

Set the alarm limits according to your hospital's standards.

Rezeroing a transducer

You can rezero a transducer at any time, after again opening the transducer stopcock to atmospheric air. If the transducer has already produced pressure readings, rezeroing provides a new zero reference for the Propaq.

If the zero value is not accepted, the Propaq Encore continues to use the previous zero reference and displays the pressure values and waveforms based on that value. If the new zero value is accepted, the new pressure values based on the new zero value are displayed, and the waveform is adjusted according to the new scale.



WARNING If a ZERO button is pressed after an invasive pressure channel has been successfully zeroed and is currently monitoring a pressure waveform, the message ZERO REJECTED will display in the invasive pressure numerics window. This message will preempt the valid invasive pressure numerics until the CANCEL button in the Invasive Pressure Menu is pressed.

WARNING If the invasive pressure channel enters an alarm condition while the ZERO REJECTED message is overriding the invasive pressure numerics, no invasive pressure numerics will flash to indicate invasive pressure is in alarm.

To remove the ZERO REJECTED message and to restore the invasive pressure numerics during an invasive pressure alarm, you must return to the invasive pressure menu and press CANCEL. This will restore the invasive pressure numerics.

How invasive pressure is displayed

From the invasive pressure signal, the Propaq Encore displays both a pressure waveform and pressure numeric values (systolic, diastolic, and mean). The waveform is displayed in a waveform window (if the waveform is turned on in the wave select window). The numerics are displayed in the blood pressure numerics windows.

The Propaq Encore allows you to identify the pressure measurement with a selectable label, and the numerics can be displayed in different formats.

The pressure waveform scales are not displayed until you zero the transducer. Once the zero reference has been established the scales automatically appear.

Rescale Mode

In this mode, there are two scales and two labels for these pressure waveforms.

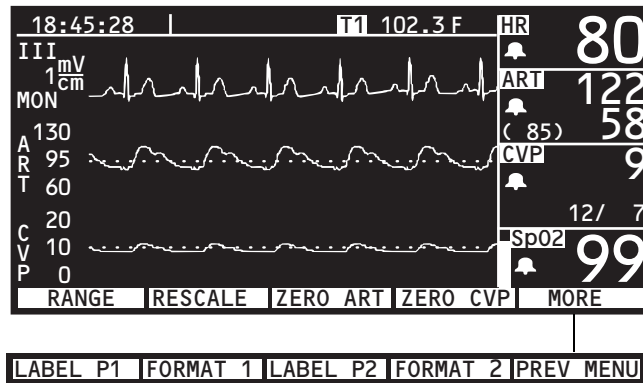

Numeric formats

- RANGE** Sets the display to Range Mode. All invasive pressure waveforms monitored are displayed against the same scale. You can select one of five Propaq Encore pressure scales. If two waveforms have a great difference in their pressures, the higher pressure waveform may not be visible if it is out of range of the scale. Press **RANGE** until the desired scale appears.
- RESCALE** Sets the display to Rescale Mode. Each invasive pressure waveform is displayed against its own scale. Each time you press the button, the scale is automatically selected based on the highest and lowest pressure levels of each pressure waveform.
- ZERO** Zeroes the selected pressure channel, or cancels zeroing in process.
- CANCEL** The ZERO button changes to CANCEL while zeroing.
- LABEL** Selects a label for the pressure channel. The selectable labels are:
 ART—arterial, PA—pulmonary artery, CVP—central venous pressure, ICP—intracranial pressure, UA—umbilical artery, and UV—umbilical vein.
 You can still use the generic Propaq Encore pressure label, P1 or P2.
- FORMAT** The Propaq Encore displays the invasive pressure values in two different numeric formats in the pressure numerics window. You can select which pressure value(s) are most prominently displayed.

Range Mode

In this mode, there is one scale and one label for both pressure waveforms.

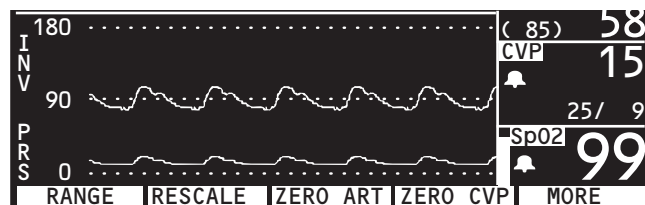

Invasive pressure messages

The following messages can appear in the numerics window.

NOT ZEROED (or NO ZERO). No zero reference has been established. The monitor displays the pressure waveform, but to protect against erroneous readings, the pressure waveform scale is not displayed. To remove this message, zero the transducer.

ZEROING. This message briefly appears as the transducer is being zeroed.

ZEROED. This message appears after the zero value has been accepted. It remains for eight seconds and is replaced by the current pressure values.

ZERO REJECTED (or REJECT). Unable to establish a zero reference value. The message remains until the CANCEL button is pressed.

CANCELED. This message appears if CANCEL is pressed while the channel is zeroing.

These equipment messages can appear in an equipment alert window.

TRANSDUCER NOT DETECTED. The transducer connection is broken.

TRANSDUCER SHORT CIRCUIT. This message appears when the Propaq Encore senses a short in the transducer. The transducer should be replaced.

INCOMPATIBLE TRANSDUCER. Check the compatible transducers listed in the Welch Allyn *Products and Accessories* guide to ensure you are using a compatible transducer.

NIBP

Intended use

The Propaq Encore noninvasive blood pressure channel (NIBP) indirectly measures arterial pressures using an inflatable cuff. If ECG is also monitored, the Propaq Encore synchronizes the NIBP measurement process to the occurrences of the R-wave, increasing accuracy in cases of extreme artifact, diminished pulses, or some dysrhythmias.



WARNING The patient's limb should be periodically observed to ensure that the circulation is not impaired for a prolonged period of time.

WARNING The Propaq Encore should never be used to monitor NIBP on one patient while simultaneously monitoring ECG on another patient.

WARNING If a noninvasive blood pressure measurement is suspect, repeat the measurement. If you are still uncertain about the reading, use another method.

WARNING Do not attempt to take NIBP pressures on patients during cardiopulmonary bypass.

WARNING Some or all NIBP safety functions are disabled in the NIBP TEST screen in the Service Menu. Do not attempt to conduct NIBP TEST when the cuff is attached to a patient.

The Propaq Encore NIBP channel has been calibrated to agree with a central invasive blood pressure. Diastolic pressures may be 5 to 10 mmHg lower than the auscultatory equivalent. Systolic pressures may be lower than radial invasive equivalent.

Neonatal Mode is intended for use on infants of up to about 44 weeks gestational age in neonatal care settings. The Neonatal Mode provides the lowest cuff pressure and shortest inflation time limits to ensure patient safety and comfort.

Pediatric Mode is intended to be used on larger infants and small children up to nine years old in pediatric care settings. This mode supports the widest range of cuff sizes and a higher range of patient numerics for the hypertensive infant or child while still restricting the cuff pressure and inflation times to limits lower than those allowed for adults.

Adult Mode provides the full range of patient numerics and cuff pressures but limits the cuff sizes available to the standard child cuff and larger.

NIBP measurements are affected by normal physiological pressure variations from reading to reading. Normal respiration may affect pressure by as much as 10 to 20 mmHg. Patient's emotional state, body position, and cuff fit may also adversely affect NIBP measurements. In some individuals, the act of taking blood pressure readings may alter the blood pressure. Successive readings on the same patient may vary for the above reasons.

The static accuracy of the Propaq's internal manometer can be verified by a qualified biomedical engineer using a mercury column manometer (refer to the *Propaq Encore Service Manual*). The accuracy of the Propaq's determination of systolic, diastolic, and mean pressures in a clinical setting can only be assessed by careful statistical analysis of controlled clinical trials of representative patient populations.

Improve NIBP accuracy with Smartcuf®

NIBP measurements can be adversely affected by many factor such as cardiac arrhythmias, sudden changes in blood pressure, body motions such as convulsions or shivering, bumping the cuff, vibration, vehicle motion, or weak pulses.

The patented Smartcuf software filtering technology greatly increases NIBP measurement accuracy in the presence of motion artifact or diminished pulses. Smartcuf synchronizes the NIBP reading with the R-wave of the patient's ECG to eliminate noise created by external stimuli such as patient motion or vibration. The monitor must perform ECG monitoring while using Smartcuf.

To enable the Smartcuf filter:

- Connect the ECG leads to the patient and perform ECG monitoring during NIBP.
- From the Main Menu, press **NIBP** to display the NIBP Menu and set Smartcuf to ON.

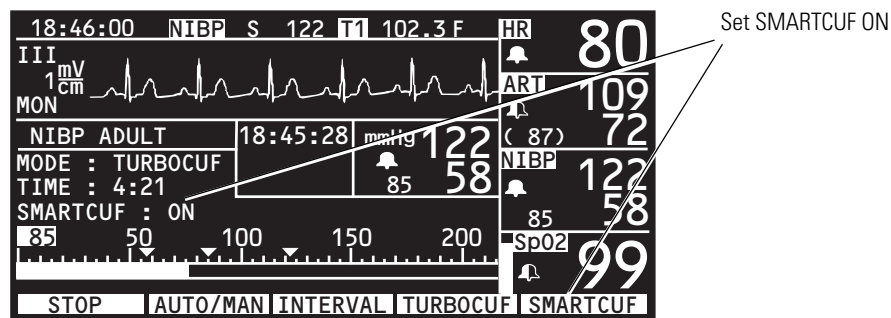

If artifact is so severe while Smartcuf is enabled that it affects the accuracy of an NIBP measurement, that measurement is marked with a special symbol on the display and on printouts

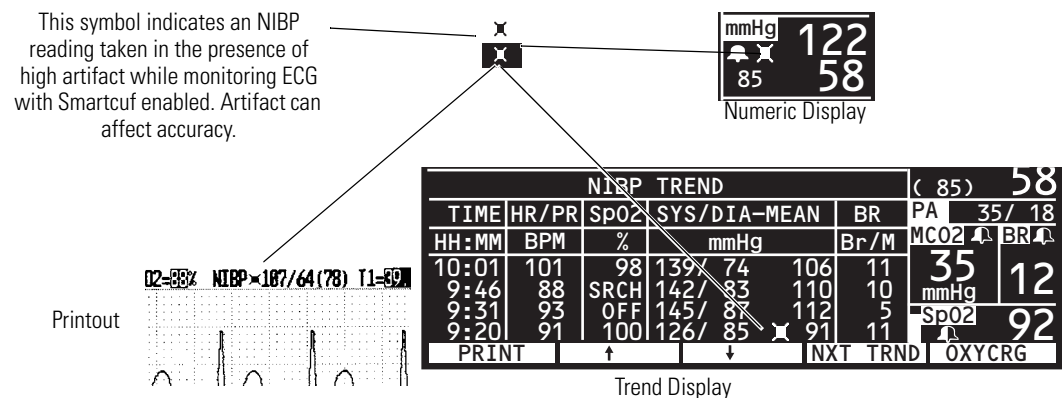

There may be some situations where it is desirable to disable Smartcuf. This may include situations with very extreme motion artifact, certain types of arrhythmias, or other situations where it is not possible to obtain a good ECG signal. NIBP measurements can still be performed when Smartcuf is disabled.

To disable Smartcuf, from the Main Menu press **NIBP** to display the NIBP Menu and set Smartcuf to OFF.

NIBP connector and cuffs

Use Propaq with approved hoses and cuffs listed in the Welch Allyn *Products and Accessories* guide. The Propaq Encore uses a single-hose cuff. Cuffs that conform to AAMI or AHA guidelines should be used. Select the proper size of cuff based on the limb circumference.

	Neonate	Pediatric	Adult
Hoses	Neonate/Infant	Adult	Adult
Cuffs (typical cuff labeling)	Neonate #1 to #5 (disposable); newborn, infant (reusable)	Newborn, infant, small child, child, small adult	child, small adult, adult, large adult, thigh
Recommended limb circumference	up to 15 cm	7.7 to 25 cm	greater than 15 cm



WARNING When monitoring NIBP, match the Propaq patient mode to the style of the cuff. For neonates, set the monitor to Neonatal Mode unless the circumference of the limb is too large for the cuff. In that case, use the Pediatric Mode. In the Pediatric Mode, the maximum cuff inflation pressure can exceed 150 mmHg, and two retries are allowed.

For information about patient mode specifications, see “NIBP” on page 104.

Preparation

Setting up for noninvasive blood pressure monitoring requires three steps: place the cuff on the patient and connect the cuff to the monitor, set up the NIBP channel, and set the NIBP alarm limits.



WARNING Before you use a Propaq on a new patient, always turn it off for a few seconds, then turn it on again. This clears the prior patient’s NIBP cuff inflation target, trend values, and alarm limit settings.

At powerup, the Propaq has an NIBP default inflation pressure (cuff inflation target) based on the patient mode (see “NIBP” on page 104 for the values). After each NIBP measurement, the Propaq adjusts the target inflation pressure to optimize the next NIBP measurement. To avoid possible patient discomfort, be sure to turn the monitor off and then on between different patients to reset the cuff inflation target to the default value.

Place and connect the cuff

1. Squeeze as much air from the cuff as you can before placing it on the patient.

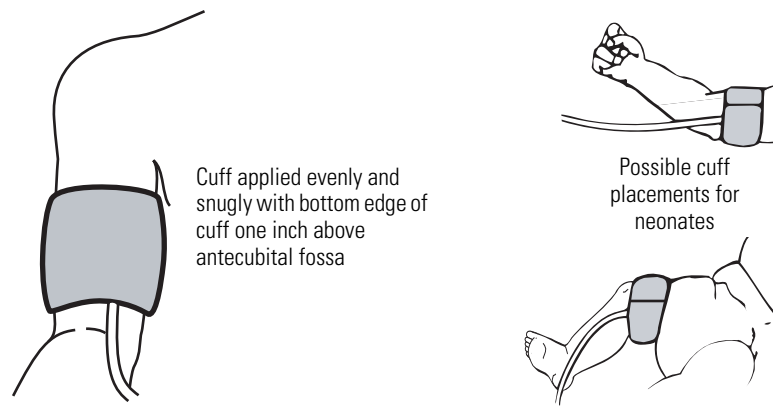

2. Place the cuff on the limb.

When you place the cuff, it should ideally be placed at the same level as the heart. If above the heart, add 1.9 mmHg to the NIBP measurement for every inch the cuff is above the heart. If below the heart, subtract 1.9 mmHg for every inch.

The cuff should fit snugly, but not be uncomfortable. The hose must not be kinked or pinched.

Ensure that the cuff tubing is centered over the brachial artery.

Note A cuff that is not properly connected to the patient may result in a false reading if the patient and cuff are moved by motion artifact or clinical personnel during the NIBP measurement. Always verify the cuff is properly placed on the patient.

3. Screw the hose connector onto the NIBP connector on the monitor's left side.
4. If motion artifact such as shivering, coughing, or vehicle motion interferes with NIBP readings, do the following:

Position the patient's limb away from the body so the applied cuff is not in contact with the patient's body or any other object such as a bed rail. Try to keep the cuff at the same level as the heart.

Connect the ECG leads to the patient and perform ECG monitoring during NIBP.

Set up the NIBP channel

Press the **NIBP** button to display the status window and menu.

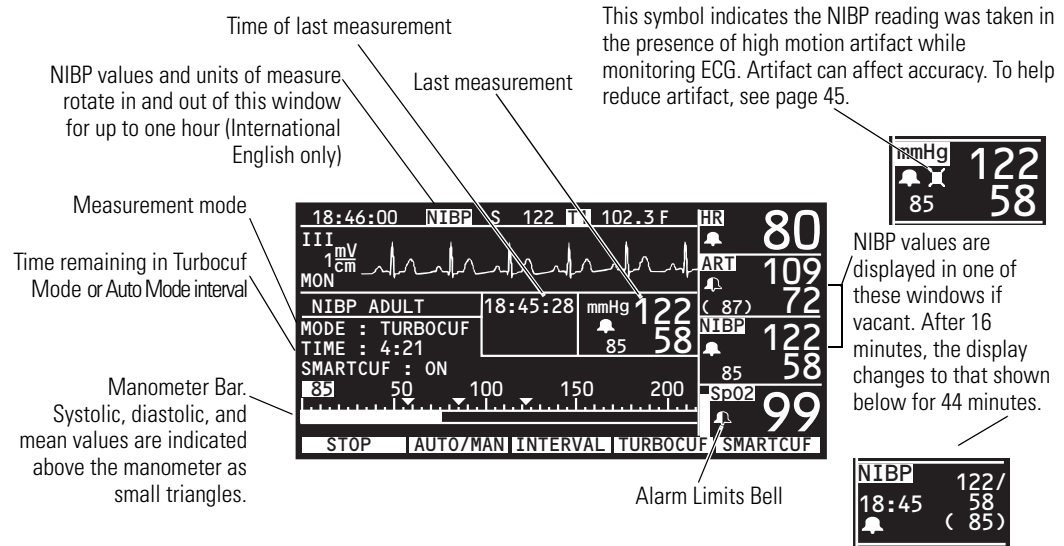

- START/STOP** Starts and stops NIBP measurements. Any time the Propaq Encore is taking a noninvasive pressure measurement, the **START** button changes to **STOP** so you can stop the measurement in progress. This button initiates the same action as the **START/STOP** button at the left side of the screen. Pressing **STOP** will automatically vent the cuff.
- AUTO/MAN** This button switches the mode between Automatic or Manual Mode. The Manual Mode is the default unless you change it by reprogramming your Propaq. Measurements can be taken at intervals of 1, 2, 3, 5, 10, 15, 30, and 60 minutes. Press **START** to initiate a measurement.
- INTERVAL** Selects the interval at which NIBP measurements are automatically taken. The interval you select, ranging from one minute to 60 minutes, is shown on the display next to the word **TIME**.
- TURBOCUF** Automatically starts NIBP measurements and continues to take as many measurements as possible within five minutes.
- SMARTCUF** Enables or disables the Smartcuf motion artifact filter. NIBP measurements can still be taken when Smartcuf is off. Artifact may interfere with the accuracy of NIBP measurements with Smartcuf off.

NIBP Displayed in Waveform Window

By turning on NIBP in the wave select window, the NIBP numerics can be displayed in a waveform window.

The numerics are shown in large characters for 16 minutes for each new measurement taken...

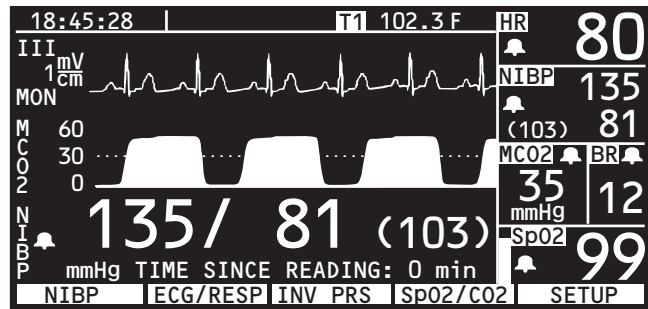

... and then they change to the smaller characters for 44 minutes. The numerics are removed after 60 minutes.

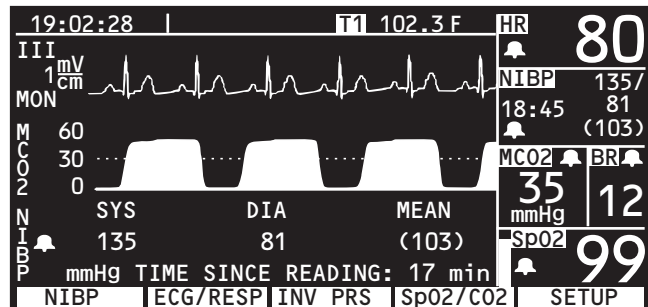

If NIBP is the only vital sign being monitored, the numerics are displayed in a waveform window above a trend window.

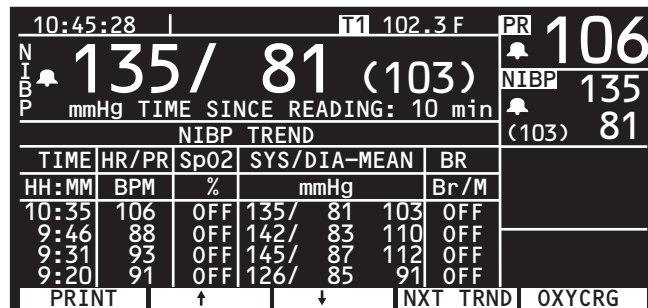

Set the NIBP alarm limits

Set the alarm limits according to your hospital's standards.

NIBP display default settings

To select which vital sign waveforms are displayed, press MAIN MENU, SETUP, WAVE SEL to display the Wave Select window.

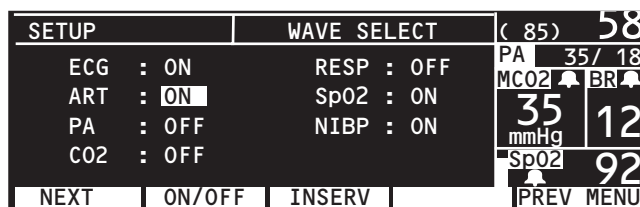

To enable the display of a waveform or large NIBP numerics, select ON (ECG cannot be set to OFF). The monitor displays the first three active waveforms set to ON in the order of priority listed in the Wave Select window. If NIBP is ON and only one or two other waveforms are ON and active, the monitor displays large NIBP numerics in a waveform window.

Important information about automatic measurements

A blood pressure measurement will begin when the minute of the time of day clock is evenly divisible by the interval. For example, if the interval is set to 10 (minutes), measurements will begin at the hour and at 10, 20, 30, 40, and 50 minutes past the hour. Note, however, that for intervals 1, 2, or 3 (minutes), measurements begin 1, 2, or 3 minutes after the interval is set. For example, if the 1 minute interval is selected at 10:45:20, the next measurement starts at 10:46:20.

The start time may be delayed if the previous measurement ended within 30 seconds of the scheduled start time, because the monitor requires that the cuff pressure be below 5 mmHg for a minimum of 30 seconds between measurements to allow time to restore blood flow to the limb.

NIBP messages

The following NIBP messages can appear in the equipment alert window. An NIBP caution message also appears in the numerics window. If an error number (ERR# x) is listed in an NIBP trend printout or display, it indicates that the corresponding NIBP equipment alert occurred.

AIR LEAK, CHECK HOSE (ERR# 1). The Propaq Encore could not properly inflate cuff. Check the hose and cuff for obvious leaks, such as O-rings in the hose connections.

CUFF NOT DETECTED (ERR# 2). During cuff inflation the detected pressure did not sufficiently rise. Check that the cuff connection is tight and take the measurement again.

KINKED HOSE, CHECK HOSE (ERR# 3). The Propaq Encore could not properly inflate cuff. Check for a kinked hose between the monitor and the patient.

OVERPRESSURE CONDITION (ERR# 4). The pressure in the cuff exceeded the acceptable limits for patient mode. Check the hose and try taking another measurement.

WEAK PULSES, CAN'T FIND SYS/DIA (ERR# 5). There are not enough pulses to determine the systolic or diastolic pressures, but a mean pressure is available. Try reapplying the cuff after squeezing as much air from it as you can.

ARTIFACT, CAN'T FIND SYS/DIA (ERR# 6). The systolic or diastolic pressures are unreliable due to artifact, but a mean pressure is available. May be caused by patient motion.

NO PULSES DETECTED (ERR# 7). The cuff may not be properly applied to the patient, or the patient may not have detectable pulses due to shock or arrhythmias.



WARNING The Propaq Encore cannot differentiate between physiologic and cuff application causes of the NO PULSES DETECTED message. Always evaluate the patient for presence of life threatening conditions whenever this message occurs.

CONNECT ECG TO REDUCE NIBP ARTIFACT (ERR# 8). NIBP artifact prevents a valid reading. Connect ECG electrodes to improve NIBP measurements.

NO VALID BLOOD PRESSURE FOUND (ERR# 9). This message can occur due to motion artifact, the Propaq Encore being set in the wrong patient mode, or the wrong hose or cuff being used in relation to the patient mode.

CALIBRATING, PLEASE WAIT (ERR# 10). The Propaq Encore periodically recalibrates the NIBP channel to ensure it can properly make NIBP determinations. Normal monitor operation continues while the NIBP channel is calibrating. If the NIBP channel has not updated its calibration in 15 minutes, the channel will briefly deactivate until a new calibration has occurred.

LOW BATTERY, NIBP DISABLED (ERR# 11). The battery lacks sufficient voltage to be able to operate the NIBP channel. Connect the Encore to the ac power adapter.

SERVICE REQUIRED, NIBP DISABLED (ERR# 12). Have the monitor serviced.

CUFF TOO LARGE FOR PATIENT MODE (ERR# 13). The monitor detects a cuff too large for the current patient mode. First, verify the patient mode. If the patient mode is correct, make sure the cuff fits snugly. If this alert occurs in Neonatal Mode, change the patient mode to Pediatric Mode and check alarm limits. If the alert occurs in Pediatric Mode, change to Adult Mode and check the alarm limits. Note that different pressures and retries are used for each mode as stated in "NIBP" on page 104.

KINKED OR NEONATE HOSE (ERR# 14). This message occurs when the neonate hose is detected in adult patient mode. Change the hose or the patient mode selection.

ARTIFACT PRESENT, MINIMIZE ARTIFACT (ERR# 15). The monitor has detected too much artifact to allow accurate readings. Take steps to reduce artifact. Position the patient's limb away from the body so the applied cuff is not in contact with the patient's body or any other object such as a bed rail. If the Smartcuf motion artifact filter is on, make sure that the ECG leads are properly connected to perform ECG monitoring during NIBP. If the Smartcuf motion artifact filter is off, consider turning it on (and connect ECG if not already connected).

The following messages can appear in the NIBP status window.

CALIBRATING. The NIBP channel is running an internal calibration.

DISABLED, LOW BATT. See LOW BATTERY, NIBP DISABLED above.

NIBP DISABLED, SERVICE REQUIRED. See SERVICE REQUIRED, NIBP DISABLED above.

RETRY. Since the Propaq Encore did not receive a valid NIBP reading, it will automatically attempt to take another reading.

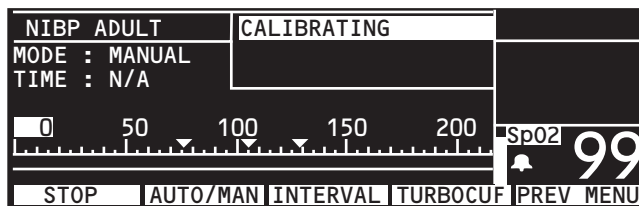

The following message can be displayed if the monitor detects a system error.

REMOVE CUFF FROM PATIENT. See page 75.

NIBP IN PROGRESS message

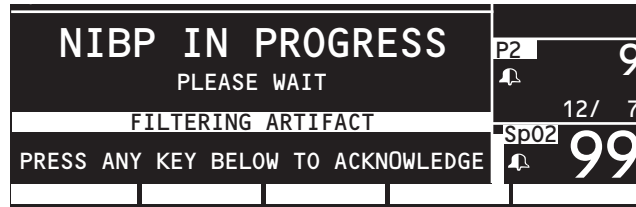

The monitor displays this message when noise or artifact such as vehicle motion causes a delay while measuring NIBP. To remove the message, press any button below the screen. To cancel the NIBP measurement, press STOP.

Temperature

Intended use

Propaq Encore monitors provide two temperature channels (except for the HP-side panel option). When both channels are active, the difference temperature (ΔT) is also displayed. You can select °C or °F.

Temperature connectors and probes

Propaqs are intended to be used with approved temperature probes listed in the Welch Allyn *Products and Accessories* guide. Other temperature probes that do not match the performance specifications of these approved probes may produce incorrect temperature readings.

Preparation



WARNING Application and use of metal-jacketed temperature probes that come in contact with conductive objects or clinical personnel during electrocautery may cause burns at the patient-probe/electrode contact points.

1. Place the probe on the patient, and plug it into one of the connectors on the Propaq's side panel. Within a few seconds, the Propaq Encore will display the temperature.
2. To select the temperature units (°C or °F), press **SETUP MORE, MORE, SERVICE, YES** (to access the Service Menu), **MORE, MORE, SETTINGS**. Use the **NEXT** and **CHANGE** buttons to select and set the temperature units as desired. The Propaq Encore automatically updates the temperature display to show the newly selected units. Changing units does not clear Temperature trends.
3. Set the alarm limits according to your hospital's standards.

How temperature is displayed

Temperature is displayed as a numeric only, in a window at the top of the Propaq Encore screen, in °C or °F. This area displays all temperature measurements (T1, T2, ΔT), one at a time.



Temperature messages

The following messages can appear in an equipment alert window. A temperature caution message will also appear in the temperature numeric window when one of these messages appears (except PROBE NOT DETECTED).

PROBE NOT DETECTED. This message occurs when the Propaq Encore has successfully measured temperature and a probe is then disconnected. Reconnect the probe or acknowledge the equipment alert by pressing any menu button.

PROBE SHORT. Verify that the probe is properly inserted in the left side panel. If so, replace probe.

CALIBRATION ERROR, TEMP DISABLED. This message appears when the Propaq Encore has detected that it cannot accurately measure the temperature. The monitor should be serviced.

Malfunction of the temperature probes may result in inaccurate readings. Confirm suspect readings.

Pulse oximetry (SpO₂)



WARNING Oxygen saturation measurements using pulse oximetry are highly dependent on proper placement of the sensor and patient conditions. Patient conditions such as shivering and smoke inhalation may result in erroneous oxygen saturation readings. If pulse oximetry measurements are suspect, verify the reading using another clinically accepted measurement method, such as arterial blood gas measurements on a co-oximeter.

WARNING Tissue damage can be caused by incorrect application or use of a sensor (e.g., wrapping the sensor too tightly, applying supplemental tape, failing to periodically inspect the sensor site, leaving a sensor on too long in one place). Refer to the Directions for Use provided with each sensor for specific instructions on application and use, and for description, warnings, cautions, and specifications.

WARNING Sensors exposed to ambient light while not applied to a patient can exhibit semi-normal saturation readings. Be sure the sensor is securely placed on the patient and check its application often to ensure accurate readings.

WARNING Inaccurate measurements may be caused by venous pulsations.

WARNING The pulse oximetry option can be used during defibrillation, but the readings may be inaccurate for a short time.

WARNING A very sudden and substantial change in pulse rate can result in erroneous pulse rate readings. Be sure to validate the patient data and patient condition before intervention or change in patient care.

WARNING Interfering Substances: Carboxyhemoglobin may erroneously increase readings; the level of increase is approximately equal to the amount of carboxyhemoglobin present. Methemoglobin may also cause erroneous readings. Dyes, or any substances containing dyes, that change usual arterial pigmentation may cause erroneous readings.

WARNING Before you use a Propaq monitor on a new patient, always turn off the monitor for a few seconds, then turn it on again. This clears the prior patient's trend values, alarm limit settings, and NIBP cuff inflation target.

Each SpO₂ sensor is designed for application to a specific site on the patient within a certain size range. To obtain optimal performance, use an appropriate sensor and apply it as described in the sensor's directions for use.

If excessive ambient light is present, cover the sensor site with opaque material to block the light. Failure to do so may result in inaccurate measurements. Light sources that can affect performance include surgical lights (especially those with a xenon light source), bilirubin lamps, fluorescent lights, infrared heating lamps, and direct sunlight.

If NIBP will be monitored while using SpO₂, place the NIBP cuff on a different limb than the SpO₂ sensor to help reduce unnecessary SpO₂ alarms. For optimal measurements, avoid placing the SpO₂ sensor on the same limb as an arterial catheter or intravascular line.

Loss of pulse signal can occur if the sensor is too tight, there is excessive ambient light, an NIBP cuff is inflated on the same limb as the sensor, there is arterial occlusion proximal to the sensor, the patient is in cardiac arrest or shock, or the patient has hypotension, severe vasoconstriction, severe anemia, or hypothermia.

Perform SpO₂ monitoring with Masimo option

1. Attach the sensor to the patient according to the sensor manufacturer's instructions, observing all warnings and cautions.



WARNING Use only Masimo accessories and sensors with the monitor with Masimo SpO₂ option as listed in the Welch Allyn *Products and Accessories* guide (810-0409-XX).

2. Inspect the Masimo SpO₂ cable. Replace it if it shows any signs of wear, breakage, or fraying. Plug the sensor into the cable and plug the cable into the Propaq monitor.

Note The monitor displays STANDBY in the SpO₂ numeric window until it measures and displays the SpO₂ value.

As oxygen saturation increases and decreases, the pitch of the heart tone rises and falls.

The monitor self-calibrates the SpO₂ channel whenever the monitor is first turned on or a sensor is first connected to the SpO₂ channel.

3. From the Main Menu, press **SpO2** (or **SpO2/CO2**, then **SpO2**) to display the SpO₂ menu similar to the following:

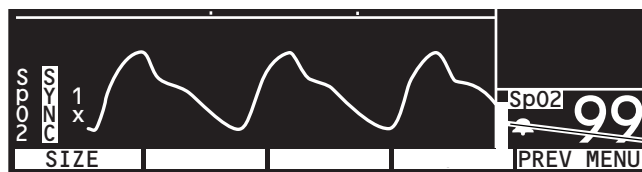

Oxygen saturation percentage

Pulse amplitude indicator (not proportional to pulse volume)

4. Press **SIZE** to adjust the waveform size for best viewing (1x, 2x, 4x, or 8x).
5. Adjust the placement of the sensor until a good SpO₂ waveform is displayed. A waveform with artifact may cause erroneous oxygen saturation readings.
6. Set alarm limits according to your hospital's standards.

Note To help minimize false alarms, the Propaq monitor briefly delays or "holds off" triggering both audible and visual alarms for limit violations for SpO₂% and Pulse Rate for 10 seconds. After the alarm hold-off period begins, if the monitor detects that the patient's vital sign has returned to acceptable limits, the monitor cancels the alarm hold-off. The next time a vital sign limit is violated, the monitor starts a new hold-off period.

The "averaging time" for SpO₂ measurements is fixed at eight seconds.

7. If patient movement interferes with measurements, consider the following possible solutions:
 - be sure the sensor is secure and properly applied
 - use a new sensor with fresh adhesive backing
 - select a different type of sensor
 - move the sensor to a less active site

Perform SpO₂ monitoring with Nellcor option

1. Attach the sensor to the patient according to the sensor manufacturer's instructions, observing all warnings and cautions.



WARNING Use only Nellcor accessories and sensors with the monitor with Nellcor SpO₂ option as listed in the Welch Allyn *Products and Accessories* guide (810-0409-XX).

2. When using a sensor extension cable, inspect the cable before use. Replace it if it shows any signs of wear, breakage, or fraying. Plug the sensor into the cable and plug the cable into the Propaq monitor, or plug the sensor directly into the monitor.
3. If the monitor SpO₂ receptacle has a locking ring, lock the connector in place by turning the locking ring clockwise until it stops. For other connectors, make sure the plug is all the way in.



Caution If you see the error message **DEFECTIVE SpO₂ SENSOR**, either the sensor is not compatible with the monitor or the sensor is not working properly. Check the Welch Allyn *Products and Accessories* guide (810-0409-XX) to be sure the sensor is compatible. If compatibility is not a problem, try another sensor.

Note The monitor displays STANDBY in the SpO₂ numeric window until it measures and displays the SpO₂ value. As oxygen saturation increases and decreases, the pitch of the heart tone rises and falls.

The Nellcor SpO₂ option periodically performs an internal adjustment which causes the SpO₂ waveform to appear flat for a brief period.

4. From the Main Menu, press **SpO₂** (or **SpO₂/CO₂**, then **SpO₂**) to display the first SpO₂ menu similar to the following:

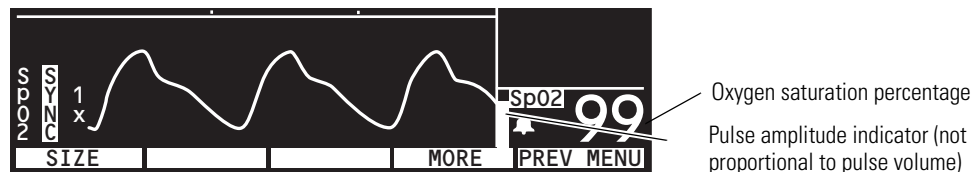

5. Press **SIZE** to adjust the waveform size for best viewing (1x, 2x, 4x, or 8x).

Note At high magnification (4x, 8x), some waveforms may appear truncated. To view these waveforms, reduce the size until the complete waveform appears.

6. Adjust the placement of the sensor until a good SpO₂ waveform is displayed. A waveform with artifact may cause erroneous oxygen saturation readings.
7. Press **MORE** to display the second SpO₂ menu:



8. Press **RESPONSE** to select the appropriate time required to measure SpO₂:

Response	Indications for Use
NORMAL: 5-7 seconds	Use for relatively stable patients.
FAST: 2-3 seconds	Use when patient movement is minimal.
SLOW: 10-15 seconds	Use when patients exhibiting movement are preventing accurate measurement at NORMAL setting.

9. If the C-LOCK function is desired, press **C-LOCK** to set it to ON.

Note C-LOCK synchronizes the pulse oximeter's systole determination to the R-wave to reduce the effects artifact may have on SpO₂ measurements. Under some conditions you may find more stable SpO₂ readings with C-LOCK set to ON. SYNC appears next to the waveform when synchronization to the ECG has been obtained. Synchronization takes a few seconds to establish the first time. If C-LOCK is on and the HR source is SpO₂, the heart rate source is automatically changed to ECG. An ECG signal must be present or C-LOCK does not activate. If you get false SpO₂ alarms with patients with low perfusion states or multiple arrhythmias, try turning off C-LOCK.

10. Set alarm limits according to your hospital's standards.

Note To help minimize false alarms, the Propaq monitor briefly delays or "holds off" triggering both audible and visual alarms for limit violations for SpO₂% and Pulse Rate for 10 seconds. After the alarm hold-off period begins, if the monitor detects that the patient's vital sign has returned to acceptable limits, the monitor cancels the alarm hold-off. The next time a vital sign limit is violated, the monitor starts a new hold-off period.

11. If patient movement interferes with measurements, consider the following possible solutions:

- be sure the sensor is secure and properly applied
- use a new sensor with fresh adhesive backing
- select a different type of sensor
- move the sensor to a less active site

Perform SpO₂ “spot-check” monitoring

The SpO₂ Standby Mode allows you to remove the SpO₂ sensor from a patient without having to disable all alarms or disconnect the SpO₂ sensor cable from the Propaq monitor. You can therefore perform intermittent or “spot-check” SpO₂ monitoring.

1. While monitoring SpO₂, remove the SpO₂ sensor from the patient, but leave it connected to the monitor. When the monitor detects the lack of a pulsatile waveform, it sounds a patient alarm and displays this menu:



2. Press STANDBY to place SpO₂ into the Standby Mode.

Note The monitor suspends the SpO₂ alarm tone indefinitely and displays STANDBY in place of SpO₂ numerics. SpO₂ remains in the Standby Mode until the SpO₂ sensor is reapplied to a patient. Other vital sign monitoring is not restricted. By contrast, if you press SILENCE instead of STANDBY, the monitor temporarily suspends all alarm tones; however, the alarm tone resumes after 90 seconds if the SpO₂ sensor is still disconnected from the patient.

3. To resume SpO₂ monitoring, reapply the SpO₂ sensor to a patient.

Note The monitor exits the Standby Mode and resumes SpO₂ monitoring. The message STBY on the SpO₂ trend display and trend printouts indicates the monitor was in the SpO₂ Standby Mode.

SpO₂ messages

The following status message can appear in the equipment alert window or the SpO₂ numeric display area:

NO SENSOR DETECTED appears in the equipment alert window and indicates a probe has been disconnected from the monitor after being plugged in for more than a few seconds.

SEARCH: during the search time, the SpO₂ channel tries to detect blood pulsing through the measurement site. Once the measurement has been established, the oxygen saturation value is displayed in the numeric window.

STANDBY is displayed in the numeric window when the SpO₂ sensor is disconnected from the patient, an alarm occurs, and you press the STANDBY button. STANDBY is also displayed if you first plug the SpO₂ sensor cable into the monitor connector before attaching the SpO₂ sensor to the patient.

DEFECTIVE SpO₂ SENSOR. If you see the error message DEFECTIVE SpO₂ SENSOR, either the sensor is not compatible with the monitor or the sensor is not working properly. Check the Welch Allyn *Products and Accessories* guide (810-0409-XX) to be sure the sensor is compatible. If compatibility is not a problem, try another sensor.

Capnography (CO₂)

Intended use

The Propaq's Capnography (CO₂) option is intended to noninvasively measure the following vital signs or events: End-tidal CO₂ (ETCO₂), Inspired CO₂ (INCO₂), Breath Rate, and Apnea.

The CO₂ option is available as mainstream CO₂, sidestream CO₂, or Dualstream CO₂. Although Dualstream CO₂ provides both mainstream CO₂ and sidestream CO₂ monitoring, only one method can be used at a time. The v option is required for any Propaq equipped with the CO₂ option.

CO₂ reading accuracy is affected by the presence of interfering gases and vapors. If the CO₂ option is used on patients who are being administered oxygen (O₂) or nitrous oxide (N₂O), be sure to set the appropriate compensation setting using the GAS COMP button.



WARNING Before you use a Propaq on a new patient, always turn it off for a few seconds, then turn it on again. This clears the prior patient's trend values, alarm limit settings, and NIBP cuff inflation target.

WARNING Avoid exposing a Propaq with the CO₂ option to non-patient sources of CO₂ such as vehicle engine exhaust or smoke. When such exposure is possible, avoid opening the printer door. Exposure to these CO₂ sources can temporarily trap v within the monitor or mainstream v sensor housing, even when monitor power is off. This can temporarily cause an erroneous elevated CO₂ measurement baseline until the trapped CO₂ leaks out and the baseline returns to zero (which can require as long as 3-24 hours).



Caution The mainstream CO₂ and sidestream CO₂ options are not recommended for use during magnetic resonance imaging (MRI) procedures. The magnetic fields involved will permanently damage the CO₂ sensor.

Note CO₂ monitoring outside the specified operating temperature range can cause inaccurate CO₂ readings. The operating temperature range for the CO₂ option is different than the range of 0° to 40° C for other Propaq Encore functions:

- Mainstream CO₂ operating temperature: 10° to 40° C
- Sidestream CO₂ operating temperature: 5° to 40° C

Mainstream CO₂ option

The mainstream CO₂ option measures the carbon dioxide content of a patient's inhaled and exhaled breath. A mainstream sensor is attached to an airway adapter in series with a ventilator's patient breathing circuit.

Patients using mainstream CO₂ must either be intubated or breathing through a well-fitting face mask connected to a breathing system such as an anesthesia circle system.

Sidestream CO₂ option

The sidestream CO₂ option measures the carbon dioxide content of a patient's inhaled and exhaled breath. A sidestream sensor is located within the Propaq monitor. The patient's expired gas is aspirated from the airway and sent through a sampling line and sidestream watertrap to the internal sensor.

Patients using sidestream CO₂ can either be intubated or non-intubated using a CO₂ Sampling cannula or a combination CO₂ Sampling/Oxygen Delivery nasal cannula.

CO₂ measurements and display

The measured CO₂ levels are normally displayed as a waveform and an ET/CO₂ numeric value. (The CO₂ waveform can be viewed when it is selected for display and the higher-priority IBP waveforms are not displayed.) If the INCO₂ numeric value is at an alarm level greater than 7.5 mmHg (or 1 kPa or 1%), it is also displayed.

If mainstream CO₂ is active, the Propaq displays MCO₂. If sidestream CO₂ is active, the Propaq displays SCO₂. The Propaq displays CO₂ if either or both the mainstream sensor and sidestream watertrap are installed in the Propaq but neither are active.

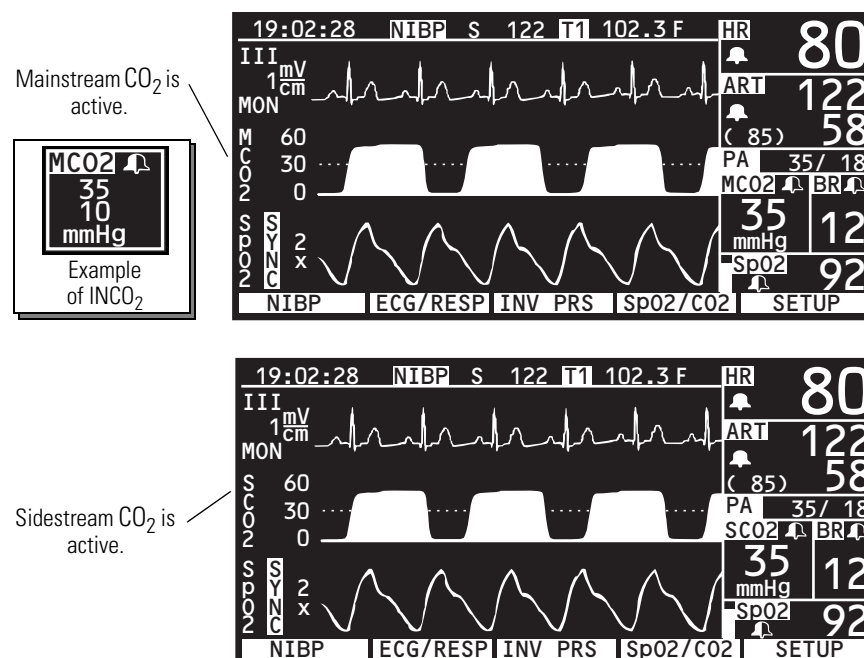

Displayed values of ET/CO₂ and INCO₂ are the highest and lowest values (respectively) of CO₂ measured during the time interval set by the RESPONSE setting on the CO₂ Menu.

You can set upper and lower alarm limits for ET/CO₂, and an upper alarm limit for INCO₂. The monitor only displays the numeric value for inspired CO₂ (INCO₂) if it is in alarm or if it is greater than or equal to 7.5 mmHg (or ≥ 1 kPa or 1%). Refer to the CO₂ specifications in the Propaq Encore Reference Guide for more information.

Breath rate measurements

Breath Rate (BR) is determined from the CO₂ sensor. The Propaq displays a numeric BR value next to the CO₂ values. You can set upper and lower alarm limits for BR.

Apnea events

In the Adult and Pediatric Mode, you can set the apnea delay to 6, 10, 15, 20, 25, or 30 seconds. In the Neonatal Mode, you can set the apnea delay to 6, 10, 15, or 20 seconds. The Propaq initiates an alarm in response to each apnea event longer than the apnea delay setting.

When an apnea event is detected, the BR numeric automatically goes to 0 and an apnea alarm occurs. After the alarm ceases, the Propaq prints an Apnea Ticket if the Apnea Ticket setting in the Printer Setup window is set to ON.

Numeric area status messages

The following status messages can appear in the numeric display area:

OFF indicates no CO₂ source is selected.

SRCH indicates the MCO₂ or SCO₂ sensor is preparing for a measurement.

UNCAL indicates the monitor has detected a problem such as a lack of calibration, an obstruction, or a low battery.

WARM UP indicates mainstream CO₂ has been activated and is preparing for operation. This typically requires 30 seconds at room temperature.

START UP indicates sidestream CO₂ has been activated and is preparing for operation. This typically requires 30 seconds at room temperature.

CO₂ display menus and status window

To access the first CO₂ menu, press **SpO₂/CO₂, CO₂** from the Main Menu

RANGE	mm/s		MORE	PREV MENU
-------	------	--	------	-----------

RANGE Selects the CO₂ waveform scale (range)

mm/s Sets the display sweep speed for CO₂ and RESP

Mainstream CO₂ menu and status window

When mainstream CO₂ is active, press **MORE** from the first CO₂ menu to access the MCO₂ menu and the MCO₂ status window:

C02			(85)	58
GAS COMPENSATION: OFF			PA	35 / 18
RESPONSE : NORMAL			MCO2	BR
CO2 SOURCE : MAINSTREAM			35	12
SWEEP SPEED : 6.25 mm/s			mmHg	
BAROMETER : 762.0 mmHg			SpO2	92
GAS COMP	RESPONSE	SOURCE		PREV MENU

GAS COMP Selects the measurement compensation for CO₂ measurements

RESPONSE Sets the response time for CO₂ measurement (NORMAL, FAST, OR SLOW)

SOURCE	Changes between mainstream CO ₂ and sidestream CO ₂ monitoring (if both options are installed), or disables CO ₂ monitoring Setting CO ₂ SOURCE to OFF allows you to disable CO ₂ monitoring without removing the sensor. When the CO ₂ SOURCE is set to OFF, the Propaq displays OFF for CO ₂ numerics.
SWEEP SPEED	The CO ₂ and RESP display sweep speed (set by the mm/s button)
BAROMETER	The ambient barometric pressure

Note To change CO₂ units, use the Settings Menu under the Service Menus. Changing these units will clear CO₂ trends.

Sidestream CO₂ menu and status window

When sidestream CO₂ is active, press **MORE** from the first CO₂ menu to access the SCO₂ menu and the SCO₂ status window:

CO ₂	(85)	58
GAS COMPENSATION:	OFF	PA 35/ 18
RESPONSE	: NORMAL	SCO ₂ BR
CO ₂ SOURCE	: SIDESTREAM	35
SWEEP SPEED	: 6.25 mm/s	mmHg 12
BAROMETER	: 762.0 mmHg	SpO ₂ 92
FLOWRATE	: 175 mL/min	
GAS COMP	RESPONSE	SOURCE
		FLOWRATE
		PREV MENU

GAS COMP	Selects the measurement compensation for CO ₂ measurements
RESPONSE	Sets the response time for CO ₂ measurement (NORMAL, FAST, OR SLOW)
SOURCE	Changes between mainstream CO ₂ and sidestream CO ₂ monitoring (if both options are installed), or disables CO ₂ monitoring Setting CO ₂ SOURCE to OFF allows you to disable CO ₂ monitoring without removing the sensor. When the CO ₂ SOURCE is set to OFF, the Propaq displays OFF for CO ₂ numerics.
SWEEP SPEED	The CO ₂ and RESP display sweep speed (set by the mm/s button)
BAROMETER	The ambient barometric pressure
FLOWRATE	Sets the sampling flow rate to either 90 or 175 ml/min. You can change the flow rate while sidestream CO ₂ is active

Note To change CO₂ units, use the Settings Menu under the Service Menus. Changing these units will clear CO₂ trends.

Mainstream CO₂ monitoring

1. Select the appropriate airway adapter.

Use only accessories provided or recommended in the Welch Allyn *Products and Accessories* guide. Always refer to the manufacturer's Directions for Use for instructions about operation, cleaning, and replacement.



WARNING Do not attempt to verify operation of the CO₂ sensor by blowing through it directly. Always blow through an attached airway adapter. Otherwise, a small amount of CO₂ from your breath may enter the CO₂ sensor housing and cause a small shift in the measured CO₂ values. It may take 3-24 hours for the sensor to return to proper calibration.

WARNING Do not clean and/or reuse a single-patient-use airway adapter. When a single-patient-use airway adapter becomes occluded, replace it.

2. Connect the adapter, ventilator circuit, and CO₂ sensor according to the manufacturer's instructions.

Adult airway adapter

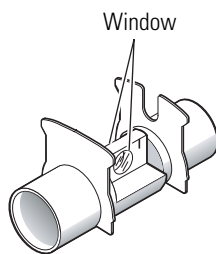

Low dead space airway adapter

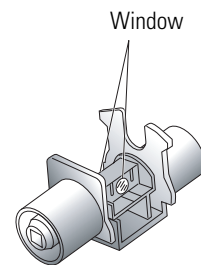

WARNING Prior to using an airway adapter, always look through the window lumen and inspect the adapter for inadvertently lodged obstructions and for window integrity.

WARNING If the sensor does not easily slide onto the adapter, do not attempt to force these components together. They fit together in only one way. Take care not to damage the glass windows.

WARNING After attaching the sensor to the adapter, check the adapter again for proper placement of the sensor and for window integrity.

WARNING When attaching the airway adapter, position the adapter so the sensor is on top to avoid fluid collection in the sensor airway slot. Any concentration of fluids here can cause inaccurate CO₂ readings.

WARNING Always check to make sure there are no leaks in the breathing circuit. Check all of the connections.

3. Plug in the CO₂ sensor cable to the mainstream CO₂ connector on the Propaq left side panel.
4. Set up the CO₂ channel and alarms. Follow the steps described on page 62.



WARNING When disconnecting the CO₂ sensor from the tracheal or endotracheal tube, check the sensor to determine how hot it is. If it is too hot for patient comfort, do not allow it to come into contact with the patient.

Note When disconnecting the airway adapter from the ventilator circuit, always detach the CO₂ sensor from the airway adapter before removing the airway adapter from the ventilator circuit.

How to set up the CO₂ channel and alarm limits

After you connect the mainstream CO₂ sensor or sidestream CO₂ watertrap adapter, follow these steps to set up the CO₂ channel and alarm limits.

Note After you connect a mainstream CO₂ sensor or sidestream CO₂ watertrap adapter, the Propaq displays the waveform briefly without a value range. It displays WARM UP (for mainstream) or START UP (for sidestream) in the CO₂ numerics window. After about 20 seconds, the Propaq displays the CO₂ measurement and waveform range.

1. Press **SpO2/CO2, CO2** to display the first CO₂ Menu.
2. Press **RANGE** until you see the desired waveform scale range on the Propaq screen. The range choices are shown below.

Units	Waveform Scale Range		
mmHg	0-100	0-60 (default setting)	0-30
kPa	0-14	0-8	0-4
%	0-14	0-8	0-4

Note If an inspired value is displayed indicating patient rebreathing (non-zero INCO₂), check the patient breathing circuit for proper function. Verify the sensor calibration against room air. If the Propaq continues to display inspired values, return the sensor to Welch Allyn for service.

3. Press **mm/s** to select either 3.13, 6.25 or 12.5 mm/sec. The default setting is 6.25 mm/sec. This sweep speed also applies to RESP.
4. Press **MORE** to view the CO₂ status window.
5. If either O₂ or N₂O is being administered to a patient, press **GAS COMP** to set the proper gas compensation as listed below. If no other gas is being administered, set GAS COMPENSATION to OFF. (OFF is the default setting.)

Gas Administration Level/ GAS COMP Setting	ETCO ₂ or INCO ₂ Value
OFF	CO ₂ value = actual CO ₂ value
O ₂ > 50%, No N ₂ O	CO ₂ value = actual CO ₂ value x 1.03
N ₂ O > 50%	CO ₂ value = actual CO ₂ value x 0.952

Note If the ETCO₂ value is displayed as + + +, verify calibration against a known reference gas. If the sensor calibration is not accurate, return it to Welch Allyn for service.

6. Press **RESPONSE** to select either NORMAL, SLOW, or FAST.

The FAST setting is recommended where a sudden step change in ETCO_2 is of concern, such as that induced by an air embolus in certain neurosurgical procedures.

A SLOW response will decrease ETCO_2 false alarms when breath morphology varies considerably from one breath to the next.

The default setting is NORMAL.

Response Time Setting	Sampling Period	Typical Indications for Use
FAST	15 seconds	During neuroanesthesia
NORMAL	30 seconds	During routine use
SLOW	45 seconds	To decrease ETCO_2 false alarms

7. Set alarm limits for ETCO_2 , INCO_2 , and Breath Rate.



WARNING For patient safety, it is recommended that the Breath Rate alarm limits always be turned on and set appropriately.

Motion artifact or other factors can cause false RR/BR alarms. To help minimize false alarms, the Propaq delays or “holds off” triggering a RR/BR alarm for 5 seconds. After this holdoff period begins, if the Propaq detects that the patient’s RR/BR vital sign has returned to acceptable limits, the Propaq cancels the alarm holdoff. The next time a RR/BR limit is violated, the Propaq starts a new 5-second RR/BR alarm holdoff period.

8. Set the alarm limit for Apnea Delay—this is the maximum time allowed between two successive breaths before an Apnea alarm occurs.

After the first breath has been detected, the Apnea alarm limit setting will be automatically turned on for as long as the CO_2 channel is active. The RR/BR and Apnea Alarm Limit window is shown below. STAT SET does not affect the Apnea limit.

ALARM LIMITS		UPPER	LOWER	(85)	58
RR/BR	Br/M:	30	5	PA	35/ 18
APNEA	DELAY:	15 secs		MCO2	BR
				45	12
				mmHg	
				SpO2	92
NEXT	UP	DOWN	ON/OFF	NEXT PAGE	

Sidestream CO₂ monitoring



WARNING If the sidestream CO₂ option is connected to a ventilatory circuit, be sure to adjust appropriate ventilator or anesthesia system settings to compensate for the sampling flow volume (90 or 175 ml/min) that is aspirated from the ventilatory circuit by the sidestream CO₂ option.

WARNING Do not use sidestream CO₂ if flammable anesthetic gases are in use.

Setting up for sidestream CO₂ monitoring requires these major steps:

1. Connect the watertrap.
2. Set up the CO₂ channel and alarm limits.
3. Connect to a non-intubated patient.

OR

4. Connect to an intubated patient.

Use only accessories provided or recommended in the Welch Allyn *Products and Accessories* guide. Always refer to the manufacturer's Directions for Use.

Note Breath rates greater than 50 breaths/minute may reduce the reported ETCO₂ values. Select the 175 ml/min flow rate to minimize errors at higher breath rates.

The 175 ml/min flow rate is recommended for intubated adult patients.

When monitoring a small child with a rapid respiratory rate, mainstream CO₂ can provide a more accurate representation of the expired CO₂ waveform.

Connect the water trap

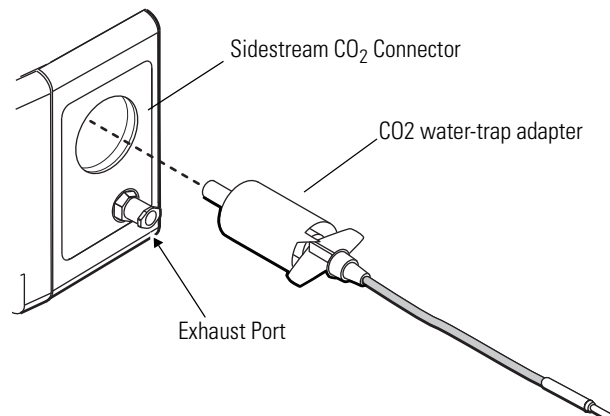

WARNING - Do not connect sample line or patient input to exhaust port.

1. Firmly insert the sidestream CO₂ watertrap adapter into the sidestream CO₂ connector on the Propaq left side panel.

Set up the CO₂ channel and alarm limits

1. Follow the steps described on page 62.

Connect to a nonintubated patient

1. Position the cannula on the patient according to the manufacturer's instructions.



WARNING The cannula is disposable and should only be used for a single patient. Do not reuse the cannula for another patient.

WARNING If oxygen is being delivered while using sidestream CO₂, be sure to use a CO₂ Sampling and O₂ Delivery Cannula. Using a different type of cannula could obstruct oxygen delivery.

WARNING The exhaust port for sidestream CO₂ is an output for the expired gases from the patient and any connected breathing apparatus. The exhaust port is intended only for connection to gas collection equipment such as gas scavenger devices. **Do not allow any other connection to the exhaust port.**

Note If you use a gas scavenging system with sidestream CO₂, be sure to install it according to the manufacturer's instructions. The scavenging system should comply with ISO 8835-3:1997 (E).

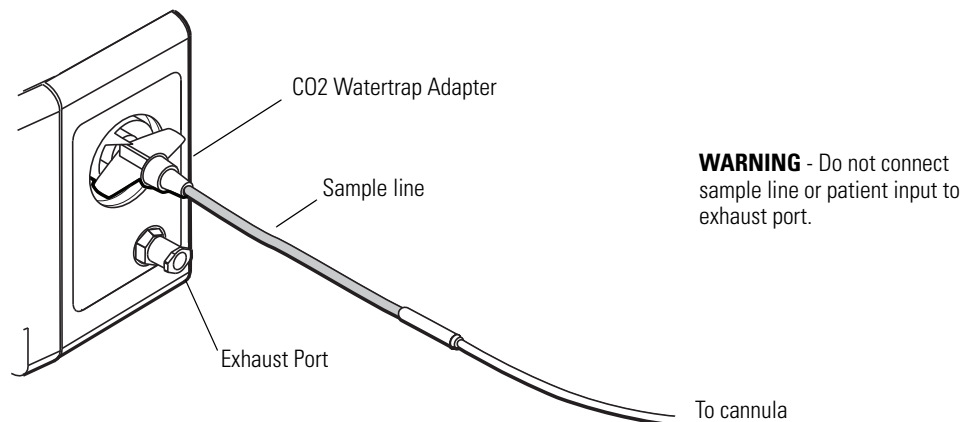

Note If you are using a watertrap and sample line instead of the one-piece CO₂ gas sampling system, perform steps above with the following changes: attach the watertrap to the monitor, then attach the sample line to the watertrap.

Connect to an intubated patient

1. Connect the gas sampling elbow and elbow connector into the patient's breathing circuit according to the manufacturer's instructions.

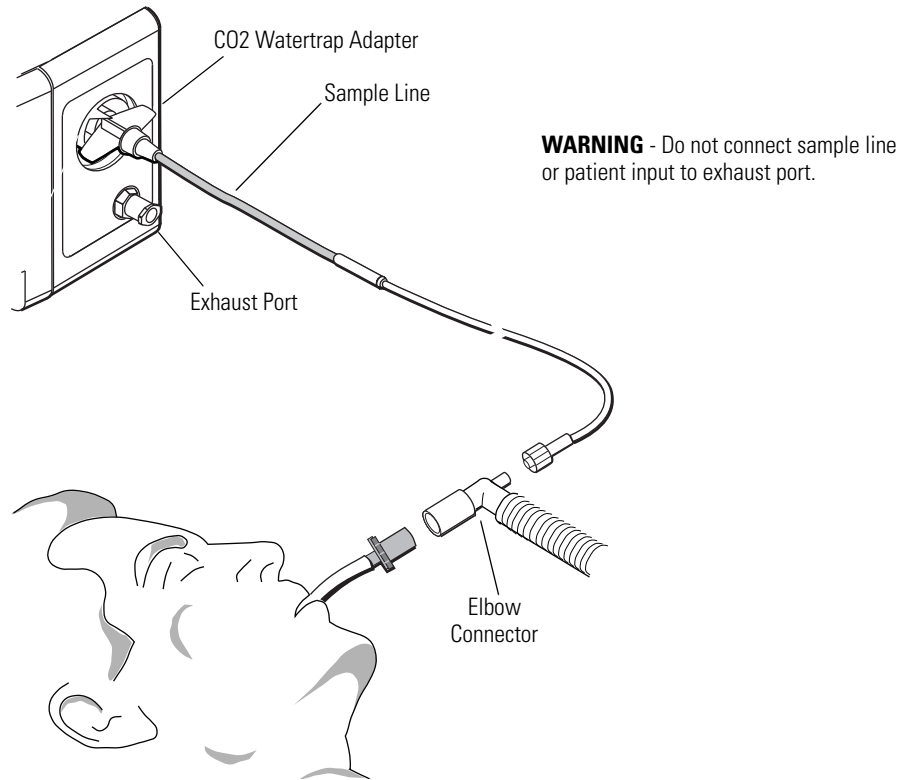

WARNING  The exhaust port for sidestream CO₂ is an output for the expired gases from the patient and any connected breathing apparatus. The exhaust port is intended only for connection to gas collection equipment such as gas scavenger devices. **Do not allow any other connection to the exhaust port.**

Note If you use a gas scavenging system with sidestream CO₂, be sure to install it according to the manufacturer's instructions. The scavenging system should comply with ISO 8835-3:1997 (E).

Note If you are using a watertrap and sample line instead of the one-piece CO₂ gas sampling system, perform steps above with the following changes: attach the watertrap to the monitor, then attach the sample line to the watertrap.

CO₂ messages

Mainstream CO₂ messages

Equipment messages for the mainstream CO₂ option can appear on the display in an equipment alert window and in numeric zones.

If a sensor is damaged, contact Welch Allyn' Technical Services Department for information on sensor service options.

ALTIMETER FAILURE - RANGE. The Propaq is operating at an altitude outside the mainstream CO₂ option's operating altitude range of -2,000 to 15,000 feet. Returning the monitor to within this range automatically cancels this message and restores operation.

ALTIMETER FAILURE - RATE. The altimeter has detected that the ambient pressure is changing at a rate greater than 100 mmHg/minute. When the rate of change is back within the 100 mmHg/minute range, disconnect and reconnect the CO₂ sensor to the Propaq.

DEGRADED WAVEFORM, CHECK ADAPTER (UNCAL appears in the numerics area). The mainstream CO₂ adapter is obstructed or the CO₂ sensor has failed. The CO₂ waveform is displayed without range values. Replace the adapter or replace the sensor.

LACK OF WAVE, CHECK ADAPTER, SENSOR. Either the airway adapter is obstructed or the CO₂ sensor has failed. Replace the airway adapter if it is obstructed. The sensor must be unplugged and plugged in again.

LOW BATTERY, HEATER DISABLED (UNCAL appears in the numerics area). The Propaq's battery voltage is too low. The CO₂ waveform is displayed without range values. To continue operation, plug the ac power adapter into the Propaq.

NO MAINSTREAM SENSOR DETECTED (SRCH appears in the numerics area). The mainstream CO₂ sensor has been disconnected from the Propaq after providing CO₂ values. Disconnect and reconnect the sensor to the Propaq if necessary.

NON-PROTOCOL SENSOR (UNCAL appears in the numerics area). A CO₂ sensor has been connected that does not match Welch Allyn's specifications. The CO₂ waveform is displayed without range values. Replace the sensor with a Welch Allyn CO₂ sensor.

SENSOR FAILURE, CALIBRATION ERROR. A sensor is defective or out of calibration. The sensor will be disabled. Replace the sensor.

SENSOR FAILURE - EEPROM. The sensor has failed. Replace the sensor.

SENSOR FAILURE - HEATER. The sensor's temperature control circuit or the Propaq's CO₂ circuitry has failed. Try replacing the sensor. If the message reappears, have the Propaq serviced.

SENSOR FAILURE - MOTOR DRIVE. The sensor's motor drive (in the sensor head) has failed. Replace the sensor.

SENSOR TEMPERATURE TOO HIGH. The sensor's temperature is too high. The sensor's ambient operating range is 10° to 46° C. When the ambient temperature returns to this range, this message is automatically removed and operation is restored.

WARM UP or WARM (appears in the numerics area). The sensor heater is warming up. Wait 20 to 30 seconds for the sensor to heat. Values should appear in the numerics area when the sensor is sufficiently warm.

Sidestream CO₂ messages

Equipment messages for the sidestream CO₂ option can appear on the display in an equipment alert window.

ALTIMETER FAILURE - RANGE. The Propaq is operating at an altitude outside the sidestream CO₂ option's operating altitude range of -2,000 to 15,000 feet. Returning

the monitor to within this range automatically cancels this message and restores operation.

ALTIMETER FAILURE - RATE. The altimeter has detected that the ambient pressure is changing at a rate greater than 100 mmHg/minute. When the rate of change is back within the 100 mmHg/minute range, disconnect and reconnect the CO₂ sensor to the Propaq.

ALTIMETER NOT CALIBRATED - EEPROM - The sidestream CO₂ option has not been calibrated. Refer the Propaq to a Biomedical Engineer for calibration.

AMBIENT TEMPERATURE TOO HIGH. The sensor temperature is too high. The sidestream CO₂ option is disabled until the ambient temperature is within the operating range specifications.

AMBIENT TEMPERATURE TOO LOW. The sensor temperature is too low. The sidestream CO₂ option is disabled until the ambient temperature is within the operating range specifications.

CALIBRATION ERROR, SERVICE REQUIRED. Send the Propaq to a Biomedical Engineer for service.

DEGRADED WAVEFORM, SERVICE REQUIRED. Send the Propaq to a Biomedical Engineer for service.

LACK OF WAVEFORM, SERVICE REQUIRED. Send the Propaq to a Biomedical Engineer for service.

MOTOR FAILURE, SERVICE REQUIRED. The sensor hardware has failed. Send the Propaq to a Biomedical Engineer for service.

NO WATERTRAP DETECTED. There is no sidestream CO₂ watertrap or CO₂ watertrap installed. Install a watertrap or CO₂ watertrap adapter.

OCCLUSION - CHECK EXHAUST PORT/TUBING. Blockage has been detected on the pneumatic exhaust port. Check the exhaust port and related tubing for occlusions. Make sure that the sampling line and any inputs to the patient breathing apparatus are not connected to the exhaust port.

OCCLUSION - CHECK WATERTRAP/TUBING. Blockage has been detected on the sidestream CO₂ input. Check the watertrap, sample line, and any connected tubing for occlusion.

PUMP FAILURE, SERVICE REQUIRED. The pump is not able to maintain the target flow rate. Send the Propaq to a Biomedical Engineer for service.

SIDESTREAM STICK EEPROM FAILURE. Send the Propaq to a Biomedical Engineer for service.

SSP BOARD EEPROM FAILURE. Send the Propaq to a Biomedical Engineer for service.

4

Alarms and limits

Description of alarm and alert tone patterns

- Patient alarm tone pattern: one second on, two seconds off
- Apnea alarm tone pattern: one second on, one second off (fastest)
- Equipment alert tone pattern: one second on, four seconds off (slowest)

Note Propaq monitors connected to an Acuity Central Monitoring System can sound distinct tone patterns for certain alarms, such as life-threatening Arrhythmia and ST alarms. For further information regarding Acuity System alarm tones, please consult the *Acuity System Directions for Use*.



Silence an active patient alarm or equipment alert tone for 90 seconds

You can silence the tone of a patient alarm or equipment alert for a period of 90 seconds.

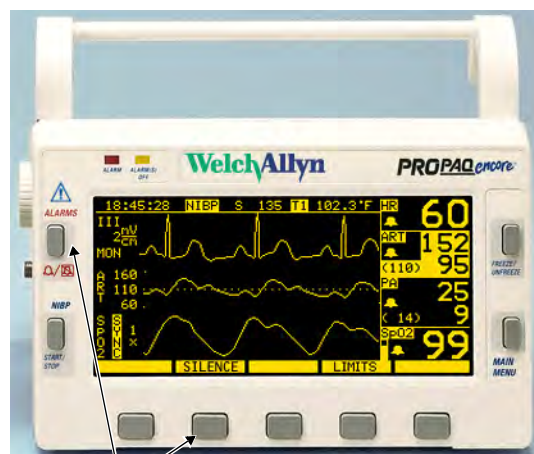

Silence an alarm or alert tone for 90 seconds





Press either key to silence the alarm or alert tone for 90 seconds.

1. Check the patient and provide appropriate care.
2. Press  /  or the **SILENCE** key.
3. After caring for the patient, make sure the appropriate alarm limits are set.

Re-enable an alarm or alert tone before the 90-second silence period has elapsed

1. Press / .

Indications during a 90-second silence period

At the Propaq Encore Monitor	At the Acuity Central Station
During the silence period, the usual <i>visual</i> alarm and alert indications are displayed.	
If a new alarm or alert occurs, the new alarm or alert tone interrupts the silence period.	Only life-threatening arrhythmia and apnea alarm tones interrupt the suspend period.
To re-enable an alarm or alert tone before the 90-seconds has elapsed, press  /  .	To resume an alarm or alert tone before the 90-seconds has elapsed, press RESUME .
If an equipment alert occurs during the silence period, you can acknowledge (dismiss) <i>all</i> indications of the alert by pressing any key, as usual.	
If the original alarm or alert condition still exists after 90 seconds, the alarm or alert tone sounds again.	



Inhibit alarm and alert tones for four minutes: 4 SUSPND

As you perform patient care, there might be occasions when you want to suspend potential or current alarm and alert tones for a period of four minutes.



Initiate a four-minute suspend period

1. Press **MAIN MENU, SETUP, ALARMS, 4 SUSPND**.

Resume alarm and alert tone capability before the four-minute period has elapsed

1. Press / .

Indications during a four-minute suspend period

At the Propaq Encore Monitor	At the Acuity Central Station
If an alarm or alert occurs during the suspend period, the usual <i>visual</i> alarm and alert indications are displayed.	
<i>Propaq monitors connected to Acuity Central Station:</i> Apnea or life-threatening arrhythmia alarm tones interrupt the suspend period.	Apnea or life-threatening arrhythmia alarm tones interrupt the suspend period.
<i>Standalone Propaq monitors:</i> Apnea alarms <i>do not</i> interrupt the suspend period, and arrhythmias are not detected.	
To resume alarm and alert tone capability before the 4 minutes has elapsed, press  /  .	To resume alarm and alert tone capability before the 4 minutes has elapsed, press RESUME .
If an equipment alert occurs during the suspend period, you can acknowledge (dismiss) <i>all</i> indications of the alert by pressing any key, as usual.	

Inhibit alarm and alert tones indefinitely: ALL ALARMS

Note This feature requires access to the Service Menu. The Service Menu features are not intended for use during ordinary, routine operation.

You can suspend potential or current alarm and alert tones for an indefinite period of time. The tones are disabled until someone re-enables them.



Indefinitely suspend all alarm and alert tones

1. Press **MAIN MENU, SETUP MORE, MORE, SERVICE, YES, MORE, MORE, SETTINGS, ALL ALARM, YES.**





WARNING Whenever audible alarm tones are disabled, make sure the patient is closely observed.

Resume all alarm and alert tone capability

1. Press / .

Indications during an all-alarms suspended period



At the Propaq Encore Monitor	At the Acuity Central Station
If an alarm or alert occurs during the suspend period, the usual <i>visual</i> alarm and alert indications are displayed.	
<i>Propaq monitors connected to Acuity Central Station:</i> Apnea or life-threatening arrhythmia alarm tones interrupt the suspend period.	Apnea or life-threatening arrhythmia alarm tones interrupt the suspend period.
<i>Standalone Propaq monitors:</i> Apnea alarms <i>do not</i> interrupt the suspend period, and arrhythmias are not detected.	
To resume alarm and alert tone capability, press  /  .	To resume alarm and alert tone capability, press RESUME .
If an equipment alert occurs during the suspend period, you can acknowledge (dismiss) <i>all</i> indications of the alert by pressing any key, as usual.	

Summary of alarm and alert keys and Acuity Central Station messages

The following table summarizes Silence and Suspend behaviors and Acuity Central Station messages for different combinations of current and previous Propaq monitor and Acuity software versions.

Note When your facility uses both older and newer Propaq monitors and Acuity software versions, be aware that messages vary at Acuity Central Station. Some Acuity Central Station messages do not identify specific alarm/alert tone silence or suspension states.

However, visual alarm indications still continue as usual at the Acuity Central Station and at the Propaq monitors.

Propaq Monitor version	Propaq Monitor key	Result of Propaq monitor key press	At Acuity Central Station, result of Propaq monitor key press	
			Acuity 6.30 and prior	Acuity 6.31 and later
Propaq Encore 2.5X	SILENCE or 	Silences active alarm and alert tones for 90 seconds at the Propaq monitor and Acuity Central Station. All new alarms and alerts interrupt the silence.	Alarms Suspended Message	Alarms Suspended Message
	4 SUSPND	Inhibits alarm and alert tones for four minutes at the Propaq monitor and Acuity Central Station. ^a	Alarms Suspended Message	Nurse Suspend 4 min Message
	ALL ALRM	Indefinitely inhibits alarm and alert tones at the Propaq monitor and Acuity Central Station, until someone resumes tone capability. ^a	Alarms Suspended Message	Nurse Suspend Always Message
Propaq Encore 2.4X and prior	SUSPEND or 	Suspends (for 90 seconds) the capability for patient alarm and equipment alert tones at the Propaq monitor and Acuity Central Station. ^a	Alarms Suspended Message	Alarms Suspended Message
	ALL ALRM	Turns off all patient vital sign alarm limits at the Propaq monitor and Acuity Central Station. No visual or auditory alarm indications occur until someone resumes the limits. ^a	Some Alarms Off, Set Alarm Limits Message	Some Alarms Off, Set Alarm Limits Message

a. If connected to the Acuity Central Station, life-threatening arrhythmias and apnea alarms interrupt the suspension.

Alarm holdoffs

Propaq audio and visual alarm hold-offs

Motion artifact or other factors can cause false vital sign alarms. To help minimize false alarms, the Propaq briefly delays or “holds off” triggering alarms for certain vital sign limit violations.

After the alarm holdoff period begins, if the monitor detects that the patient’s vital sign has returned to acceptable limits, the Propaq cancels the alarm holdoff. The next time a vital sign limit is violated, the Propaq starts a new alarm holdoff period. The following table summarizes the alarm holdoff periods.

Monitoring Function	Alarm Holdoff Period
HR/PR	3 seconds (except NIBP PR)
SpO ₂	10 seconds
RR/BR	5 seconds

When the Propaq is connected to the Acuity Central Monitoring System, Acuity does not receive any alarm indication from the monitor until this holdoff period expires.

Propaq audio alarm hold-off with Acuity

When a Propaq Encore in Adult or Pediatric Mode is connected to an Acuity System, the audio alarms at the bedside Propaq can be delayed up to 4 minutes and 15 seconds. The delay time is selected in Acuity software at the time of Acuity installation. Visual alarm indications are not delayed.

Note This audio alarm holdoff does *not* occur in the Neonatal mode.

Setting alarm limits

Adjust limits with STAT SET

When you want to quickly set all alarm limits, the Propaq Encore can calculate new alarm limits using the patient's current values. Press the **STAT SET** button in the Alarms Menu (SETUP, ALARMS, STAT SET). The Propaq Encore activates all alarms and calculates the limits for all monitored vital signs, except apnea delay. The monitor performs a mathematical function (addition, subtraction, or multiplication) on the current value of the vital signs to arrive at the new limits. The formulas for these calculations are shown in the table.

Vital sign	If the patient's vital sign value is	Then calculated new lower limit is	Then calculated ^a new upper limit is
Heart Rate	HR ≤ 99	HR x 0.8	HR x 1.2
	100-250	HR - 20	HR + 20
	HR ≥ 251	Unchanged	250
Pulse Rate	PR ≤ 99	PR x 0.8	PR x 1.2
	PR ≥ 100	PR - 20	PR + 20
Invasive Pressure	Inv Prs ≤ 25	Inv. Pressure - 5	Inv. Pressure + 5
	26 - 99	Inv. Pressure x 0.8	Inv. Pressure x 1.2
	Inv Prs ≥ 100	Inv. Pressure - 20	Inv. Pressure + 20
NIBP	NIBP ≤ 25	NIBP - 5	NIBP + 5
	26 - 99	NIBP x 0.8	NIBP x 1.2
	NIBP ≥ 100	NIBP - 20	NIBP + 20
Respiration Rate/ Breath Rate	RR/BR ≤ 25	RR/BR - 5	RR/BR + 5
	26 - 99	RR/BR x 0.8	RR/BR x 1.2
	RR/BR ≥ 100	RR/BR - 20	RR/BR + 20
Temperature	Temp ≥ 0°C	Temp - 0.5	Temp + 0.5
SpO ₂	SpO ₂ ≥ 0%	SpO ₂ - 5 (min. limit 50%)	100% (adult and pediatric mode) SpO ₂ + 5 (neonate mode)
ETCO ₂	ETCO ₂ ≥ 0 mmHg	ETCO ₂ - 5 mmHg (min. 15 mmHg)	ETCO ₂ + 10 mmHg
	ETCO ₂ ≥ 2.0 (% or kPa)	ETCO ₂ - 0.7 (% or kPa) (min. 2.0% or 2.0 kPa)	ETCO ₂ + 1.4 (% or kPa)
INCO ₂	INCO ₂ ≥ 0 mmHg	Not affected by STAT SET	INCO ₂ + 5 mmHg
	INCO ₂ ≥ 0 (% or kPa)		INCO ₂ + 0.7 (% or kPa)
Apnea Delay	Not affected by STAT SET		

a. New alarm limits calculated by STAT SET cannot be outside the allowable alarm limit range. If a new limit is calculated to be above or below the allowable alarm limit range, it defaults to the maximum or minimum alarm limit allowed for that vital sign.



WARNING If a patient's vital sign value falls outside of the upper or lower alarm range limit, STAT SET turns off the alarm and the alarm limit except for the following:

1. The lower alarm limits for SpO₂ and ETCO₂ are not turned off by STAT SET.
2. If HR/PR ALARM LIMITS in the Settings window is set to CANNOT TURN OFF, STAT SET affects HR/PR alarm limits as follows:
 - For an overrange HR/PR patient value (displayed as +++), the upper alarm limit is set to the maximum alarm limit, and the lower alarm limit is unchanged.
 - For an underrange HR/PR patient value (displayed as ---), the lower alarm limit is set to the minimum alarm limit and the upper alarm limit is unchanged.
 - For an indeterminate HR/PR patient value (displayed as ???), the alarm limits are unchanged.

Power-up equipment alert: program fault, settings lost

If a PROGRAM FAULT: SETTINGS LOST, TIME/DAY RESET equipment alert appears when you turn on the monitor, the monitor cannot recall the programmed custom settings and current time and date. This can occur if the battery is drained or after new software has been installed.

If this occurs, the monitor provides a special sequence of display windows to help you regain use of your monitor as quickly as possible. Refer to [“Power-up equipment alert: program fault, settings lost”](#) on page 11 and perform the described steps.

If you follow these steps and the equipment alert reappears at powerup, the monitor may need to be serviced and the battery replaced. Contact a qualified service person.

Troubleshooting system error messages

If the monitor detects a system error, it will display a message similar to the following:

```
ERROR NUMBER: 1-123-4567
REMOVE CUFF FROM PATIENT

PLEASE NOTIFY YOUR LOCAL SERVICE
REPRESENTATIVE OR WELCH ALLYN PROTOCOL, INC.
```

This type of message indicates that the monitor detected an internal system problem which may require service for the monitor. If the monitor displays this message, disconnect the monitor from the patient. Write down the error number for the service department, and send the monitor to your facility's biomedical engineering department.

Note The message REMOVE CUFF FROM PATIENT as shown above does not imply that the detected error is related to NIBP. It is simply a reminder to disconnect the NIBP cuff from the patient if a cuff is connected.

5

Trends

Every two minutes, the Propaq Encore collects the monitored vital sign numerics and stores them in its trend memory, which can save the last five hours of trend information. (See "NIBP Trends" on the next page for exceptions.) All this information can be printed and viewed as a trend print.

The trend status window and menu

There are five trends: NIBP, RESP, P1, P2, and TEMP. Except for NIBP, all vital signs are continuously monitored from the time monitoring begins to the time it ends.

Each trend shows the time of the reading, the HR/PR measurements, the SpO₂ value (if configured), and other values. The three blood pressure trends show systolic, diastolic, and mean pressures, and all but the TEMP trend show respiration rate, if it's available. Columns on the trend table show the word 'OFF' for the vital signs not being monitored. Columns on the trend table show the word 'OFF' for the vital signs not being monitored.

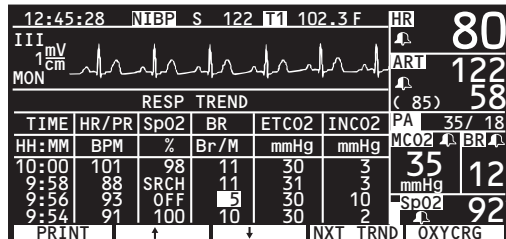

Numerics that have alarmed are highlighted.

The Trend Menu allows you to select trended data for display and print the displayed trend if a printer is attached.

PRINT Prints the displayed trend.



The Up Arrow button allows you to scroll up to the most current reading and the Down Arrow lets you scroll down to the oldest reading, four readings at a time.

NXT TRND Allows you to cycle through the current display of each trend group.

OXYCRG Prints an oxycardiorespirogram. For more information on OxyCRG, see "OxyCRG" on page 82.

How trends are accumulated

For each of the four continuous trends, numerics are sampled every two minutes to a maximum of 150 samples (up to five hours). When the maximum is reached, the trending continues but the older data is no longer stored. The readings are displayed in descending order, most recent first.

The following is programmable: which trend window comes up first. The NIBP trend window is the factory default.

To clear trend data before connecting a new patient, the monitor power must be cycled. This will prevent the trend data of a previous patient from being attributed to the new patient.

NIBP trends

A maximum of 128 NIBP readings are collected (up to 8 hours). NIBP is not measured continuously like other vital sign parameters. The numerics on this trend are captured at the time of the NIBP reading.

NIBP TREND						(85)	58
TIME	HR/PR	SpO ₂	SYS/DIA-MEAN		BR	PA	35/ 18
HH:MM	BPM	%	mmHg		Br/M	MC02	BR
10:01	101	98	139/ 74	106	11	35	12
9:46	88	SRCH	142/ 83	110	10	mmHg	
9:31	93	OFF	145/ 87	112	5	SpO ₂	92
9:20	91	100	126/ 85	91	11		
PRINT		↑	↓	NXT TRND		OXYCRG	

When the SEARCH message appears in an NIBP TREND display or printout, it indicates that the monitor was not able to complete an NIBP measurement during that period.

This symbol indicates that the NIBP reading was taken in the presence of high motion artifact while monitoring ECG. Artifact can affect accuracy. To help reduce artifact, see ["Place and connect the cuff"](#) on page 44.

If an error number (ERR# x) is listed in an NIBP TREND printout or display, it indicates that an NIBP equipment alert occurred. See ["NIBP messages"](#) on page 48 for NIBP alert error numbers and definitions.

Displaying trends

Displayed trends show the last five hours of data. Trends are displayed if you are at the main menu and have only one waveform turned on in the wave selection window. Trends are also displayed when you press the TRENDS button in the first Setup Menu.

Selecting a trend (NXT TRND)

Select the trend you want displayed by pressing the **NXT TRND** button. The trend is identified by a label at the top of the table.

P1 TREND	P2 TREND	NIBP TREND	RESP TREND	TEMP TREND
Time	Time	Time	Time	Time
HR/PR	HR/PR	HR/PR	HR/PR	HR/PR
SpO ₂	SpO ₂	SpO ₂	SpO ₂	SpO ₂
SYS/DIA-Mean	SYS/DIA-Mean	SYS/DIA-Mean	RR or BR	T1
RR or BR	RR or BR	RR or BR	ETCO ₂	T2
			INCO ₂	ΔT

6 Printing

Printing patient data

Printing waveforms

If you have an expansion module set up with your monitor, you can print any waveform by pressing either the **SNAPSHOT** or **START/STOP** button on the expansion module when the waveform is displayed on the monitor. You can also set the monitor to print automatically.

The number of seconds of data shown on the printout depends on the print speed set in the Printer Setup window.

Patient vital sign numerics are printed above the waveforms.

The ECG waveform

ECG is printed on a grid with major divisions (dotted lines) every 5 mm and minor divisions (single dots) every 1 mm. The ECG waveform is always printed if ECG is monitored.

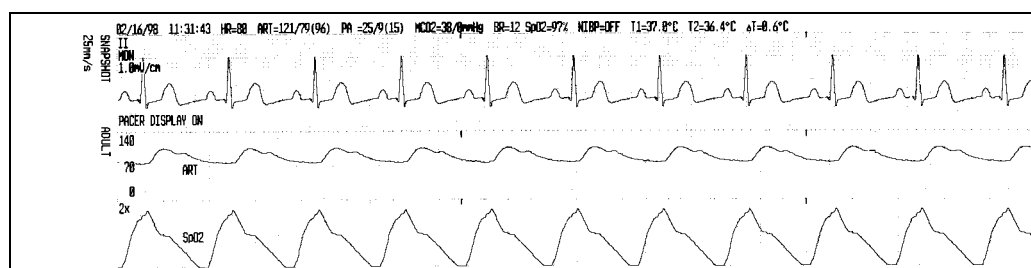

The invasive-pressure waveforms

Pressure waveforms are printed on a grid with major divisions (vertical dotted lines) every 5 mm, and the pressure scale grids are printed horizontally.

The SpO₂ plethysmograph

The plethysmograph is printed without a horizontal grid. The size is printed on the printout. Although no vertical scale is displayed for the SpO₂ waveform, a size indicator is displayed to show the relative gain of the waveform.

CO₂ and RESP waveforms

CO₂ waveforms are printed on a grid with major divisions (vertical dotted lines) every 5 mm, and the pressure scale grids are printed horizontally. The waveforms and numerics are labeled as **MCO₂** for mainstream CO₂ and **SCO₂** for sidestream CO₂. If neither CO₂ option is active, the label is simply **CO₂**.

On the **SNAPSHOT** command only, the CO₂ and RESP waveforms will be printed with different sweep speeds than the other waveforms.

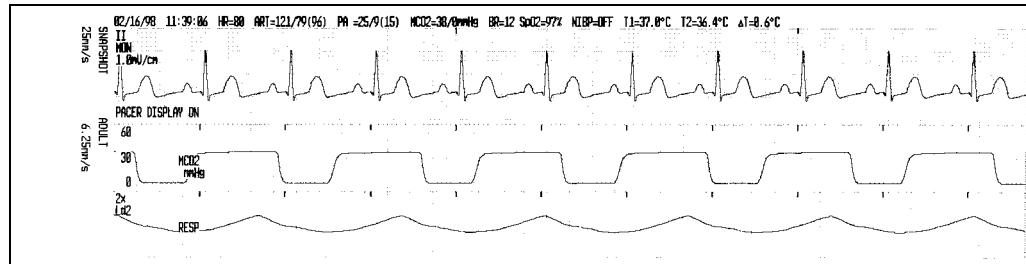

Printing NIBP measurements

You can print the results of an NIBP measurement each time one occurs. This printout is called the NIBP Ticket. The NIBP Ticket must be turned on in the Printer Setup window.

1. To turn on NIBP TICKET, press **SETUP, MORE, PRINTER**. The printer setup window appears.
2. Use the **NEXT** and **CHANGE** buttons to select and turn on the NIBP TICKET.

This symbol indicates that the NIBP reading was taken in the presence of high motion artifact while monitoring ECG. Artifact can affect accuracy. To help reduce artifact, see ["Place and connect the cuff"](#) on page 44.

NIBP TICKET		02/16/98	
TIME	HR/PR	SpO2	SYS / DIA - MEAN BP
HH:MM	BPM	%	mmHg Br/M
11:46	80	97	120 / 63 ✕ 80 12

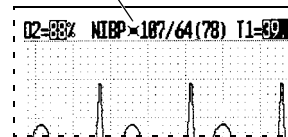

Printing the apnea ticket

The Apnea Ticket documents the length of each apnea episode.

The Apnea Ticket is printed after the patient resumes breathing . . .

APNEA TICKET (BR) 02/16/98		
TIME	HR/PR	SpO2
H:MIN:S	BPM	%
LAST BREATH:		
15:45:53	80	OFF
RESUMED BREATHING:		
15:47:02	80	OFF
ELAPSED TIME:		
00:01:09		
ADULT		

. . . and/or 60 seconds after the last breath was detected if the patient has not resumed breathing

APNEA TICKET (BR) 02/16/98		
TIME	HR/PR	SpO2
H:MIN:S	BPM	%
LAST BREATH:		
15:45:53	80	OFF
BREATHING NOT RESUMED:		
15:46:53	80	OFF
ELAPSED TIME:		
00:01:00		
ADULT		

To set the Propaq to print an Apnea Ticket after an apnea event, follow these steps.

1. From the main menu, press the following buttons: **SETUP, MORE, PRINTER**.
2. Press the **NEXT** button until APNEA TICKET is highlighted in the Printer Setup window.
3. Press the **CHANGE** button until APNEA TICKET is set to ON.

Printing when a patient alarm occurs

To set up the printer to print on a patient alarm, follow these steps.

1. From the Main Menu, press the following buttons: **SETUP, MORE, PRINTER**.
2. Press the **NEXT** button to select ALARM PRINT in the printer setup window.
3. Press the **CHANGE** button until ALARM PRINT is set to ON.

PRINTER	SETUP PAGE	(85) 58
CONTINUOUS	: 25.0 mm/s	PA 35/ 18
AUTO PRINT	: 15 minutes	MCO2 BR
ALARM PRINT	: OFF	35 12
NIBP TICKET	: OFF	mmHg
APNEA TICKET	: OFF	SpO2
OXYCRG ON ALARM	: OFF	92
NEXT	CHANGE	PR TREND MORE PREV MENU

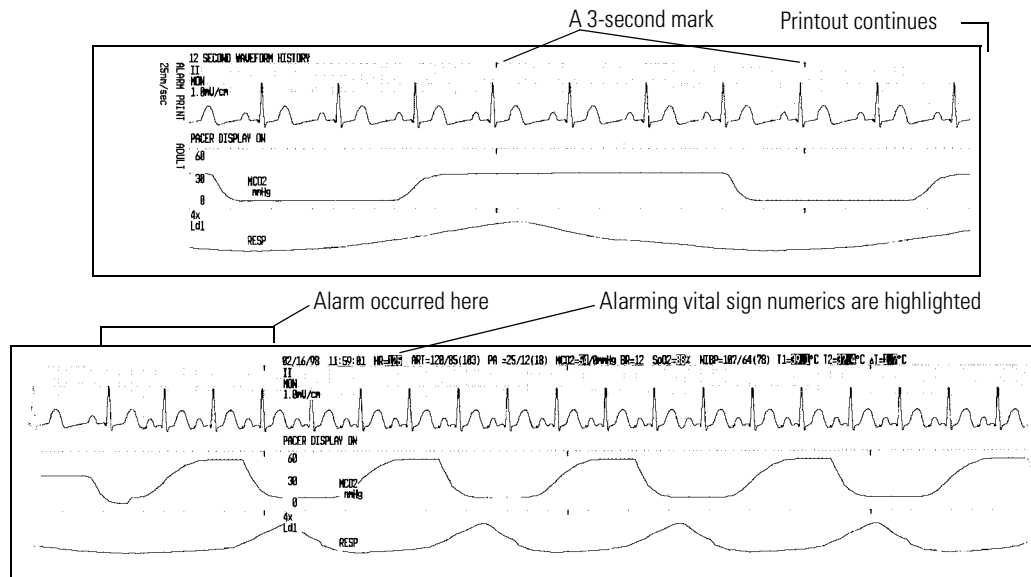

OxyCRG

The OxyCRG is a graphical printout of two minutes of continuous HR/PR and SpO₂ numerics, and a condensed respiratory waveform. If any of the parameters have been completely inactive for the two minutes prior to the initiation of the print, the associated band will be empty.

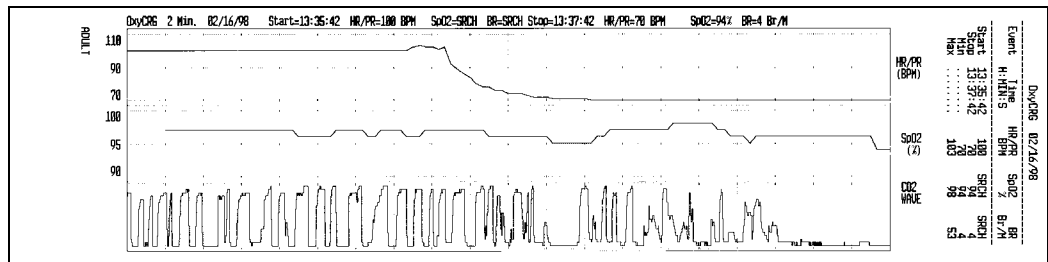

OxyCRG on alarm

When an alarm condition is detected, a print will be initiated if OXYCRG ON ALARM is turned on. If an SpO₂ or HR/PR alarm condition is detected, an OxyCRG will be queued to print 60 seconds after the alarm is detected. If an Apnea or RR/BR alarm condition is detected, an OxyCRG will be queued to print 75 seconds after the alarm is detected.

The parameters which have alarmed in the two-minute period are indicated by the highlight of the corresponding labels.

Printing trends

Printed trends are useful for reviewing the patient's vital signs over the last several minutes to the last five hours. The Propaq enables you to print one trend or several trends with a press of a button, or automatically at 4-hour intervals.

Printing a single trend

The best way to print just one trend is with the PRINT button in the Trends Menu. When you press the PRINT button, the displayed trend is printed. If you want to print a trend different from the one displayed, press NXT TRND until the desired trend is shown.

Printing several trends

The best way to print several trends at one time is to set up the printer to print the trends you want and then press the PRINT TRENDS button on the expansion module, or the PR TREND button in the Printer Menu, whenever you want the trends printed.

1. From the Main Menu, press **SETUP, MORE, PRINTER, MORE**. The printer trend select window appears.
2. Using the **NEXT** and **CHANGE** buttons, select each of the trends you want printed and turn them on. Turn off all other trends.
3. Now, each time you want to print the selected trends, press **PRINT TRENDS**.

NIBP TREND		02/16/98					
TIME	HR/PR	SpO2	SYS	/ DIA	- MEAN	BR	
HH:MM	BPM	%	mmHg			Br/M	
10:46	80	97	114	/ 67	81	12	
10:45	80	97	116	/ 67	82	12	
10:44	80	97	118	/ 68	81	12	

This symbol indicates that the NIBP reading was taken in the presence of high motion artifact while monitoring ECG. Artifact can affect accuracy. To help reduce artifact, see "Place and connect the cuff" on page 44.

Automatic trend prints

To automatically print trends at 4-hour intervals, activate AUTO TREND and select the print times.

Use the CHANGE button to set the trend print times according to the start time (clock hour) of each shift or to OFF.

Once the Propaq is set up, it will print all the selected trends at each 4-hour interval. You can place the printouts in the patient's record at the end of each work shift.

Starting times are selectable for the 4-hour interval printouts

PRINTER	TREND SELECT PAGE	(85)	58
AUTO TREND: 03 07 11 15 19 23		PA	35/ 18
NIBP : OFF		MC02	BR
RESP : ON		35	12
ART : OFF		mmHg	
PA : ON		SpO2	92
TEMP : OFF			
NEXT	CHANGE	PR TREND	MORE
		PREV MENU	

7

Acuity Central Monitoring system

Intended use



WARNING Use of equipment, accessories, and parts not recommended or supplied by Welch Allyn could result in inaccurate patient information or damage to the system.

WARNING When Acuity is inoperable, be sure to keep Acuity patients under close surveillance, especially those prone to arrhythmias. Use Acuity only in conjunction with close surveillance by trained clinicians.

WARNING Connect the Propaq Encore to an Acuity system only. Connecting to other networks could damage the monitor or injure the patient. If in doubt about the network jacks or devices, consult your facility's Biomedical Engineering Department.

WARNING Make sure the Acuity network cable is not damaged. The Acuity network cable is the sole link between the Propaq Encore and the Acuity Central Monitor.

The Acuity system is used as a central monitoring system for Propaq Encore monitors configured to interface with Acuity.

The Acuity system may be used to monitor all patients. For neonatal patients, use all Acuity features except the Welch Allyn Cordless Acuity and the arrhythmia detection option. The Acuity system is intended to be used in compliance with the instructions in this *Propaq Encore Reference Guide*, the *Acuity System Reference Guide*, and accepted hospital and clinical protocols.

Connecting to the Acuity system

1. If the Propaq Encore has already been connected to the patient, save the patient's Trends and Alarm Limit settings by keeping the monitor turned on. (The Propaq Encore transmits up to five hours of trend information when you connect it to the Acuity network.)

If the Propaq Encore has not been connected to the patient, clear any prior patient's trends and alarm limit settings by turning off the Propaq Encore and after a few seconds, turning it on again.

2. If the Propaq Encore is not already connected to the patient, attach leads and sensors to the patient as described in Chapter 2 of this reference guide.

3. Plug in the Acuity network cable to the Acuity network jack on the Propaq Encore side panel shown in the following figure. Plug in the other end of the cable to the bedside Acuity network jack.

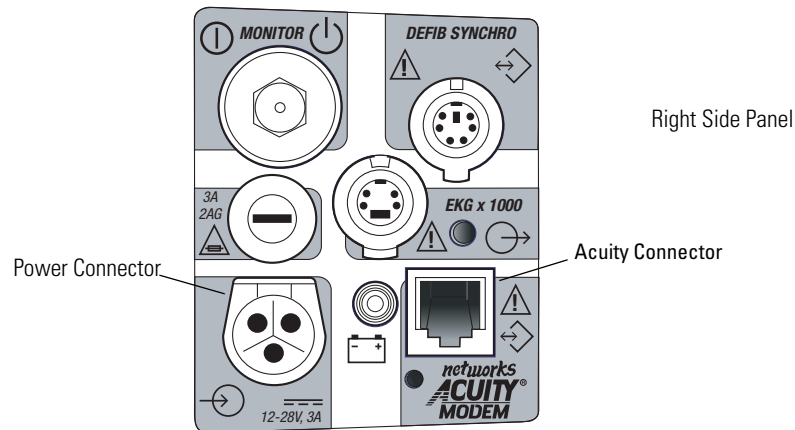

Caution Accessory equipment connected to the analog and digital interfaces must be certified according to the respective IEC standards (e.g., EN 60950 for data processing equipment and EN 60601-1 for medical equipment). Furthermore, all configurations shall comply with the system standard IEC 601-1-1. Anyone connecting additional equipment to the signal input or output connectors is configuring a medical system, and is therefore responsible that the system complies with the requirements of the system standard IEC 601-1-1. If in doubt, consult your Biomedical Engineering Department.

4. Connect the AC adapter to the Propaq Encore and the wall outlet to charge the battery. Check to see that the battery charging light on the monitor's right side panel is on.
5. Confirm the patient identification at the bedside or enter the patient information at the Acuity Central Monitor using the Patient ID Setup Window.
6. If alarm limits have not been set, do so at the Propaq Encore or at the Acuity Central Monitor using the Alarms Setup Window.

WARNING If you don't set alarm limits, Acuity uses preset settings (for arrhythmia limits), and the powerup default settings for the Propaq Encore.

Note When a Propaq Encore in Adult or Pediatric Mode is connected to an Acuity System, the audio alarms at the bedside Propaq can be delayed up to 4 minutes and 15 seconds. The delay time is selected in Acuity software at the time of Acuity installation. Visual alarm indications are not delayed.

Key-press route to Acuity menu

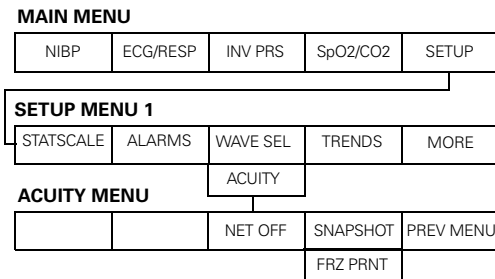

Press NET OFF to disconnect from Acuity

When you want to disconnect the monitor from Acuity, be sure to use the NET OFF button as described below. The NET OFF button is a safety feature to help make sure the patient is not disconnected accidentally. If you simply disconnect the Acuity network cable from the monitor without using the NET OFF button, the monitor and Acuity both generate equipment alert messages that must be acknowledged by an operator.

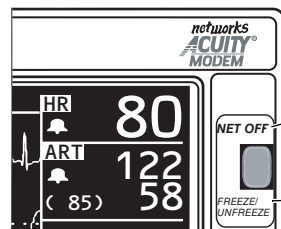

NET OFF

When the monitor is connected to Acuity, pressing this button disconnects the monitor from the Acuity network.

FREEZE/UNFREEZE

When the monitor is NOT connected to Acuity, pressing this button freezes or unfreezes the displayed waveforms.

1. To disconnect the Propaq Encore from the Acuity network, press the front panel NET OFF button.
2. Within 15 seconds, disconnect the Acuity network cable from either the Propaq Encore side panel or the bedside jack. If the patient will no longer be monitored with the Propaq Encore, turn off the monitor to erase trend information.

If you do not disconnect the Acuity network cable within about 30 seconds, the monitor and Acuity attempt to reconnect and prompt you to confirm the patient ID.

Whenever the monitor is connected to Acuity, the NET OFF function overrides the FREEZE/UNFREEZE function for the NET OFF front panel button. Therefore, you cannot freeze the displayed waveforms when the monitor is connected to Acuity. Also, you cannot initiate a Freeze Print at Acuity when connected to Acuity. When the monitor is not connected to Acuity, pressing the FREEZE/UNFREEZE button freezes or unfreezes the displayed waveforms.

Printing at Acuity

You can print various waveforms from the Propaq Encore to the Acuity system printer. To print a waveform shown on the display screen, press **SETUP, ACUITY, SNAPSHOT**. If you press the FREEZE button on the front of the Propaq Encore, the button changes from SNAPSHOT to FRZ PRNT.

Network alert message

When the Propaq Encore is connected to the Acuity system, it constantly exchanges information with Acuity. If the Propaq Encore detects an interruption in this flow of information, it displays an alert message: NETWORK FAULT, CHECK ACUITY/DATA COMM CONNECTION.

If the Propaq Encore displays this message, check the Acuity network cable to be sure it is plugged in to the side panel and to the bedside jack. If the cable is damaged, replace the cable.

If the cable appears undamaged and the Acuity system is operating normally, ask your service personnel to check the network and the Propaq Encore Acuity connector.

8

Power sources

For in-hospital operation and recharging from ac mains, an ac power adapter plugs into the monitor. Use only a Welch Allyn ac power adapter to ensure protection against risk (leakage) current hazards.

The Propaq Encore can also be powered and recharged from a dc source (isolated from ac mains) capable of supplying 12-28 Vdc and continuously supplying 25W.



Caution When a transport vehicle's battery system is used to provide input power to the Propaq Encore, surges caused by a defect in the vehicle's power system may blow a fuse in the Propaq's side panel or cause further damage to the Propaq.

Power adapter intended use

Welch Allyn power adapters are intended to be used only with Propaq monitors, and Propaq Encore monitors are intended to be recharged using only a Welch Allyn power adapter with a mating plug, and rated for your ac mains.

The power adapter contains symbols on its labeling. For definitions of these symbols, see ["Symbols"](#) on page 3.



WARNING Place the power adapter where it cannot fall and harm someone.



Caution Use of other than Welch Allyn power adapters with the plug rated for your ac mains can damage or compromise the safety of the Propaq Encore monitor and may require fuse replacement in the power adapter. Verify that the Power Adapter is set for the proper mains voltage prior to plugging it into the Propaq.

Caution Do not autoclave the power adapter. Do not operate the power adapter with a damaged case, mains power cord, or plug.

Verifying proper power-adapter configuration

Prior to using the power adapter, check it for proper voltage selection by looking in the small indicator window on the front end (by the power switch). If the number in the window does not match your ac mains source voltage (100-120V or 200-240V), the adapter should be reconfigured. See the illustration on page 91.

Your biomedical technician can change the voltage setting and fuses on the power adapter and can verify that your facility is using the correct power cord.

Power-adapter configurations

Power-adapter part numbers are listed with their rated input, fuse, output, and applicable usage. Check to be sure you are using the correct power adapter for your mains power source by comparing the part number on the power adapter to the table below. Always replace fuses with the fuses rated for the power adapter.

Part number/connector style		Rated input voltage	Rated serviceable fuses	Rated output	Application
With power switch	503-0054-00	100V-120V ac,	T800 mA/250V	16-24V dc	25 Watt requirement in countries with 100V-120V power systems.
Without power switch:	503-0093-XX	500 mA, 50/60 Hz	Time-Delay 5 x 20 mm	25 VA	
With power switch	503-0054-01	200V-240V ac	T400 mA/250V	16-24V dc	25 Watt requirement in countries with 200V-240V power systems.
Without power switch:	503-0092-XX	250 mA, 50/60 Hz	Time-Delay 5 x 20 mm	25 VA	

Replacing the power-adapter fuses

The Power Adapter contains two fuses that can easily be replaced by service personnel if necessary. The adapter can contain spare fuses.



Caution Replace each fuse only with the specified type.

Procedure

1. Unplug the power adapter's removable cord from the ac mains outlet and the power adapter.
2. Turn the power adapter so you can see the window that indicates the voltage setting.
3. Using a small, flat-blade screwdriver, carefully pry the fuse module from the power adapter.
4. Replace both fuses with the specified type.

Note Both fuses should be replaced at the same time, even if only one fuse has opened due to an overcurrent situation. The unopened fuse may have been stressed and could become unreliable.



Caution Spare fuses are contained in housings next to the fuses in the fuse module as shown in the following picture. Between the fuses is a small printed-circuit board (PCB) that sets the power adapter to the desired ac mains voltage. When handling the fuse module, the PCB may slide out.

Caution If the small PCB between the fuses has slipped out of place, slide it back into place in the fuse module, and verify that the voltage setting indicated in the window on the fuse module is correct. If the voltage setting is incorrect, simply slide the PCB out of the fuse module, rotate it 180° and slide it back into place.

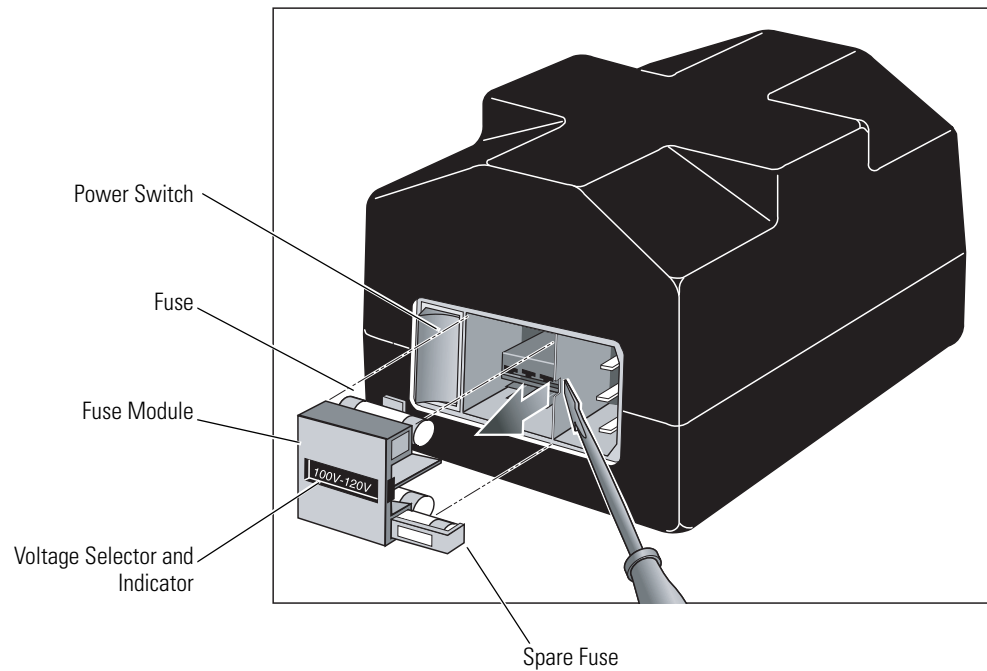

Caution Make sure the voltage selector indicates the proper ac input voltage. If you change the adapter voltage setting, you must replace all fuses to match the appropriate type specified on the bottom of the power adapter. The only fuses contained in the power adapter when shipped from the factory are fuses specified for the original adapter input voltage setting.

Battery care



Caution Leaving the monitor's lead-acid batteries in a completely discharged state may result in permanent battery damage. The batteries should be kept fully charged.

Recharging time

The battery charges to full capacity within eight hours (if the monitor remains off).

Monitor functions resumed

In most instances, most monitor functions are usable immediately after plugging in the ac power adapter and cycling the power switch. More charging time may be required before the NIBP, CO₂, and printer can be operated.

Operating times using battery power

The amount of time you can operate the Propaq Encore on each battery charge depends upon many variables including active options, frequency of NIBP measurements, frequency and length of print strips, ambient temperature, battery age and condition, and what information is displayed.

For monitors without the Expansion Module or SpO₂ option, typical monitor operating time is about 2 hours at 25° C for a new, fully-charged battery. This is when all patient channels are active and measurements are taken every 15 minutes.

For monitors without the Expansion Module but with the SpO₂ option, operating time is about 5 hours.

For monitors with the Expansion Module and printer, SpO₂ and CO₂ options, typical operating time is about 3 hours under the above conditions when print strips are generated every 15 minutes.

Monitor functions based on battery voltage

As battery voltage drops during extended monitor battery operation, error messages are displayed and monitor functions are discontinued in order of priority.

Checking battery voltage

The Propaq's battery voltage is displayed on the initial powerup screen. The battery voltage is also displayed with the Settings window.

Replacing the fuse

The Propaq Encore is protected against power surges by a 3 Ampere fuse, which can easily be replaced in the right side panel. Fuse replacement should only be performed by a qualified service person.

Note If the green Battery Charging lamp does not light when an ac adapter is connected, this fuse may be blown.

1. Disconnect the Propaq Encore from the patient.

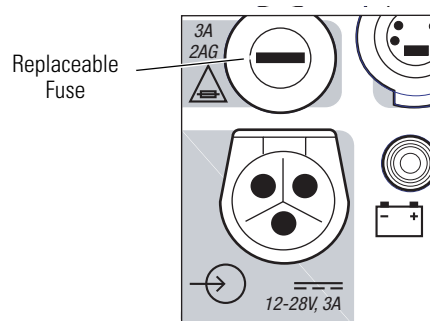

2. Disconnect the ac power adapter from the Propaq Encore's power input connector.
3. Using a small screwdriver or similar device, unscrew the fuse carrier by turning it counterclockwise.
4. Remove the fuse holder and replace the fuse with a 3 Ampere, 2AG, 250V (fast or slow acting) fuse. This fuse can be ordered from Welch Allyn or its service centers using part number 503-0058-00.

9

Care and maintenance

Avoid electrostatic discharge

When humidity in the working environment decreases, the human body and other insulators can become charged with static electricity due to friction.

To prevent unwanted electrostatic discharge (ESD), follow these standard guidelines:

- Maintain the recommended humidity of 40% to 60% in the work environment.
- Dissipate electrostatic charge before performing routine operator maintenance.

Inspect and clean the monitor and accessories

Before cleaning, thoroughly inspect the monitor and all accessories for any signs of damage, cracks, or improper mechanical function of keypads, switches, connectors, and printer paper door. While gently bending and flexing cables and tubing, inspect for damage, cracks, cuts, abrasions, extreme wear, exposed wires or bent connectors. Confirm connectors securely engage. Report damage or improper function to your service department.

Equipment	Cleaning instructions	Approved cleaning solutions	
Propaq CS Monitor ^{a b}	Wipe with a nearly-dry cloth moistened with cleaning solution. Thoroughly wipe off any excess cleaning solution. Do not let water or cleaning solution run into connector openings or crevices. ^c	Warm water Liquid soap T.B.Q. ^b Hydrogen peroxide solution	Coverage Wex-cide ^b Windex Ovation
NIBP cuff	Consult manufacturer's instructions.	Consult manufacturer's instructions.	
Cables, tubing, CO ₂ sensor ^d	Wipe gently with cloth dampened with cleaning solution. Do not immerse the CO ₂ sensor in liquid.	Mild detergent solution; also consult manufacturer's instructions.	
SpO ₂ cables	Consult manufacturer's instructions.	Consult manufacturer's instructions.	
Other accessories	Consult manufacturer's instructions.	Consult manufacturer's instructions.	

- Do not use these cleaning solutions (they may damage the monitor):** Butyl alcohol, Denatured ethanol, Freon, Mild chlorine bleach solution, Isopropyl alcohol, Trichloroethane, Trichloroethylene, Acetone, Vesphene II, Enviroquat, Staphene, Misty, Glutaraldehyde, Fantastik, Formula 409, Cidex.
- The monitor may be disinfected to comply with OSHA requirements for cleaning and decontaminating spills of blood and other body fluids. (Federal OSHA Standard on bloodborne pathogens: 29 CFR 1910.1030, 12/6/91.) **Wex-cide** (Wexford Labs, Inc., Kirkwood, MO) and **T.B.Q.** (Calgon Vestal Lab., Calgon Corp., St. Louis, MO) are disinfectants that meet OSHA requirements, and are EPA approved. Wipe away disinfectants with a water-dampened cloth after the manufacturer's recommended period of time.
- If liquid gets into the right side panel connectors, it will drain out. If moisture gets into a left side panel connector, dry the connector with warm air, then check the monitoring functions for proper operation.

- d. The mainstream CO₂ sensor may also be disinfected with Wex-cide. Follow the disinfectant manufacturer's instructions. Do not leave Wex-cide on sensor longer than 30 minutes. Thoroughly clean off residue with water-dampened cloth. Prolonged exposure of the sensor to Wex-cide will damage the sensor.



Caution Do not autoclave this product or its accessories. Do not immerse the monitor in liquid when cleaning. Do not immerse accessories in liquid when cleaning unless the accessory manufacturer's cleaning instructions instruct you to do so.

Maintenance

Service interval recommendations

At the intervals recommended below, verify the Propaq Encore for proper operation of all channels and internal circuitry. Such checks and verifications should only be carried out by a qualified biomedical service person.

Other Propaq Encore service information, including calibration procedures, is described in the *Propaq Encore Service Manual* (P/N 810-0696-XX). Refer to it for more information.

Use the following intervals for a guideline. Service may be needed more often in extreme environments (heat, cold, dust, etc.).

Recommended interval	Service action
Six months to two years	Complete functional verification; see <i>Propaq Encore Service Manual</i> Inspect the Propaq Encore for mechanical and functional damage Inspect safety labels for legibility Inspect the side panel fuse for compliance to specified rating Verify that visual and acoustic alarms are functioning properly Test patient leakage current according to IEC 601-1/1988 Test patient leakage current with mains voltage on patient-applied parts according to IEC 601-1/1988: limit 50μA ^a
Minimum every three years	Check battery capacity

- a. NOTE: The leakage current should never exceed the 50μA limit. The data should be recorded in an equipment log. If the device is not functioning properly or fails any of the above tests, do not attempt to repair the device. Please return the device to the manufacturer or to your distributor for any required repairs.

Recycling monitor components

Within the European Union

Do not dispose of this product as 'unsorted municipal waste'. Prepare it for reuse or separate collection as specified by Directive 2002/96/EC of the European Parliament and the Council of the European Union on Waste Electronic and Electrical Equipment (WEEE).



Note If the monitor or the battery is contaminated, this directive does not apply.

For more specific disposal information, see www.welchallyn.com/weee, or contact Welch Allyn Customer Service.

Outside the European Union

When the monitor or the battery reaches end of life, recycle it locally according to national, state, and local regulations, or return it to Welch Allyn.

Monitor care

Environmental operating and storage limits

Whenever possible, store the Propaq Encore at room temperature in a dry environment. For environmental operating instructions, see "[Monitor \(physical\)](#)" on page 114.



WARNING The monitor may not meet its performance specifications if stored or used outside the specified temperature and humidity ranges.

Extended storage precautions

Battery removal



Caution Storing the Propaq Encore for extended periods (more than three months) without being connected to the ac power adapter can cause damage to the battery. Even when the Propaq Encore is turned off, a very small amount of current is drawn from the battery. For long-term storage, remove the battery from the Propaq.

See the *Propaq Encore Service Manual* for procedures on removing the battery.

Note Removing the battery will cause programmed settings to be lost, but they can be reprogrammed when the battery is replaced.

Printer paper removal



Caution If a Propaq Encore has a battery installed or ac power connected and is stored for an extended period without use, the printer paper can cause damage to the printhead. Before storing a Propaq Encore for more than two months without use, remove the roll of printer paper.

Printer maintenance

Paper is loaded through the bottom of the printer.



Caution Use only low-debris printer paper purchased from or recommended by Welch Allyn. Use of other paper can cause unclear printing of patient data, damage to printing head, and eventual printer failure. Store all paper (including a monitor loaded with paper) in an environment that meets the paper storage specifications listed in Appendix B. Failure to properly store paper can result in paper discoloration and damage to the printer.

1. Lay the monitor on its back to gain access to the bottom of the printer.
2. Squeeze the locks on the paper door toward each other and pull the door toward you to open it.
3. Lift the paper roll from the holder and pull out any paper remaining in the printing mechanism.
4. Place the new paper roll onto the holder, as shown below, and pull out several inches of paper.

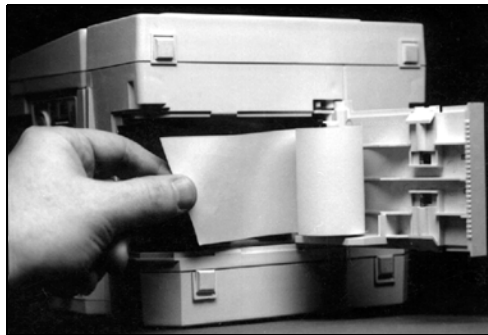

Load the new paper roll onto the spindle on the door.

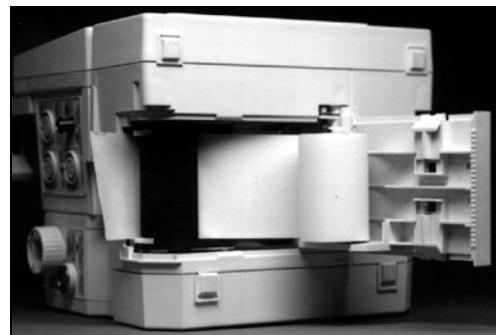

Feed the paper through the printer mechanism.

5. Slide the end of the paper into the slot of the printing mechanism until it extends out of the paper exit slot.
6. Close the paper door.
7. Place the monitor on its feet.
8. Simultaneously press the **START/STOP** button and the **PRINT TRENDS** button to produce a test print.

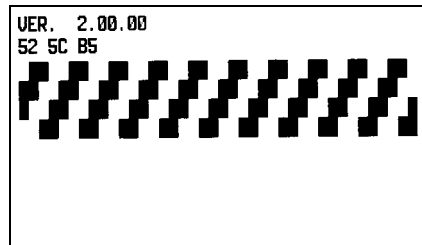

Customer services

Ordering and customer service

For ordering information, for the location of your nearest Welch Allyn sales representative or service center, or for more information on other Welch Allyn products, contact:

Welch Allyn
8500 SW Creekside Place
Beaverton, OR 97008-7107 USA
Worldwide: (503) 530-7500
In the USA, toll-free: (800) 289-2500
FAX: (503) 526-4200

Technical service

If you need technical assistance on troubleshooting, are interested in customer technical training on Welch Allyn products, or help with ordering replacement parts, contact Welch Allyn's Technical Services Department at:

Worldwide: (503) 530-7500
In the USA, toll-free: (800) 535-6663
FAX: (503) 526-4970
Internet: <http://www.monitoring.welchallyn.com/service>
Internet E-mail: solutions@monitoring.welchallyn.com

Repacking

Before returning the monitor for service, call Welch Allyn for return authorization and instructions on shipping. Repack the Propaq Encore in its original shipping container, if possible. The container is designed to protect the monitor from possible damage during shipment.

10

Specifications

ECG

The ECG channel meets all the requirements for Cardiac Monitors Heart Rate Meters and Alarms specified ANSI/AAMI EC13-1992, except for Standardizing Voltage (section 3.2.9.9). The channel also meets the American National Standard, Safe Current Limits for Electromedical Apparatus (ANSI/AAMI ES1-1993).

Characteristic	Specification
Connector	AAMI 6 pin or Hewlett-Packard compatible 12-pin style connector (optional). (See the illustration at the bottom of this table.)
Selectable Leads	I, II, III, aVR, aVL, aVF, V
Lead Fault Indicator	LA, LL, RA, RL, C, multiple
ECG Size (sensitivity) in mV/cm	4, 2, 1, 0.5, 0.2
Display Sweep Speeds	12.5, 25, and 50 mm/sec
QRS Tone Volume	High, Low, Medium, Off
QRS Tone Frequency	900 Hz. for Propaq Encore without Expansion Module, 665 Hertz when equipped with SpO ₂ but SpO ₂ not being monitored; variable pitch with SpO ₂ option and SpO ₂ being monitored
Freeze Buffer	3.9 seconds at 25 mm/sec
Bandwidth	0.5 to 40 Hz in Monitor Mode; 0.05 to 40 Hz in Extended Mode (see Real-Time ECG Analog/Defib Sync specification).
Sample Rate	364 Hz
Input Protection	Electrosurgery and defibrillator protected when used with specified ECG cables. All models also include electrosurgery interference suppression.
Lead Fail Sense Current	50 nA dc for active leads 100-200 nA dc for driven lead, depending on number of electrodes attached
Tall T-wave Rejection	Meets and exceeds AAMI (USA) EC13-1992, section 3.1.2.1.c, for 1.2 mV T-wave and 1 mV QRS using AAMI test waveform.
Common Mode Rejection	<1 mV p-p RTI for 10V rms, 50/60 Hz input, 200 pF source impedance, input unbalanced, FILTER function OFF <0.1 mV p-p RTI for 10V rms, 50/60 Hz input, 200 pF source impedance, input unbalanced, FILTER function ON
Input Impedance	>2.5 M Ω differential @ 60 Hz
Input Range (ac)	10 mV peak to peak
Input Range (dc)	Up to \pm 300 mV
System Noise	\leq 30 μ V peak-to-peak, R.T.I., with all inputs = 47K in parallel with .047 μ F.

Characteristic	Specification
QRS Detector	Adult or Pediatric Amplitude Range: 0.22 to 5.0 mV (RTI) Neonatal Amplitude Range: 0.1 to 5.0 mV (RTI) Neonatal and Pediatric Width Range (Duration): 40 to 120 msec Adult Width Range (Duration): 70 to 120 msec
Heart Rate Range	25 to 350 beats per minute (measurement) 25 to 300 beats per minute (display)
HR/PR Alarm Limit Range	25 to 250 beats per minute
Heart Rate Meter Response Time	Responds to change in heart rate within 5 to 9 seconds depending on physiological waveform. (As measured per AAMI standard EC 13-1992 clause 4.1.2.1 (f), including 3.1.2.1 parts f. and g. waveforms.) Includes 1 second readout update interval.
HR Accuracy	± 3 beats per minute or 3%, whichever is greater NOTE: AAMI Test 4.1.4 part f: Accuracy is affected (i.e., rate drops) when QRS and pacer spikes are nearly simultaneous as occasionally is the case during this AAMI test.
Heart Rate Averaging Method	Heart rate = 60 / latest average interval in seconds For higher heart rates, latest average interval = 7/8 of previous average interval + 1/8 of latest interval. For lower heart rates, latest average interval = 3/4 (previous average interval) + 1/4 latest interval. Transition rates for choice of formula include hysteresis and are 70 and 80 beats per minute.
Drift Tolerance (AAMI Specification EC13-1992, 3.2.6.3)	80 beats per minute indicated for 80 beats per minute ECG plus drift waveform
Pacer Display	Pacer indicator shown on screen if PACER function turned on; pacer spike always shown if of sufficient amplitude.
Pacer Pulse Rejection	Pacer detection range (i.e., will show the dashed vertical marker) for 0.1 ms pulses is ± 3 mV to ± 700 mV, and drops linearly to ± 2 mV to ± 700 mV for 0.2 to 2 ms pulses. Will not count as heartbeats approximately 95% of pacemaker pulses within pacer detection range, with or without AAMI (EC13 1992) tails of 4, 25, 50, 75, or 100 ms decay time constant, whose tail amplitudes are 2.5% or 25%, 2mV maximum, whether ventricular only, or A-V sequential pulses, all per AAMI tests 3.1.4.1 and 3.1.4.2
Response to Irregular Rhythm (AAMI specification EC13-1992, 3.1.2.1. Part e.)	
Ventricular Bigeminy (VB)	78 to 81 bpm (80 bpm expected)
Slow Alternating VB	57 to 65 bpm (60 bpm expected)
Rapid Alternating VB	118 to 123 bpm (120 bpm expected)
Bidirectional Systole	88 to 93 bpm (90 bpm expected)
1mV Ventricular Tachycardia	197 to 198 bpm (206 bpm expected)
2mV Ventricular Tachycardia	193 to 197 bpm (206 bpm expected)

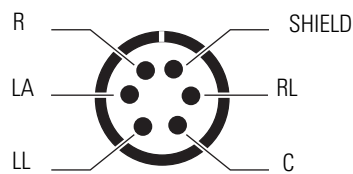

AAMI 6-pin ECG connector side panel view

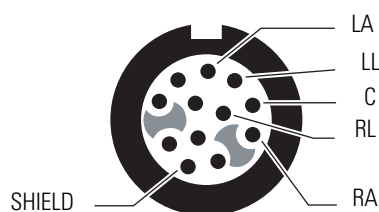

HP 12-pin ECG connector side panel view

Real-time ECG analog/defib sync

Special cables are required to interface the defib sync connector to the Physio-Control LIFEPAK 5 or LIFEPAK 6s defibrillator.

Signal	Specification
Sync Output	0 to 5V pulse, 100 ± 5 ms wide, starts within 35 ms after peak of R-wave. 15 mA short circuit current.
Real-time ECG Output	Range = ± 6 V minimum, centered about 0V, Gain = 1000X, noninverting for lead II, inverting for all other leads, delay <3 msec, 0.05-100 Hz, going to -5.9 V $\pm 5\%$ during ECG lead fail. V lead has no Real-Time analog output.
Marker Input (Defib Sync only)	Normally 0V in, a pulse either + or -3 to ± 15 V for 10-70 ms puts a marker in ECG trace. ~ 5 k Ω input res.
Shield	Common terminal for other signals

The sync and real-time ECG outputs do not operate during In-service mode.

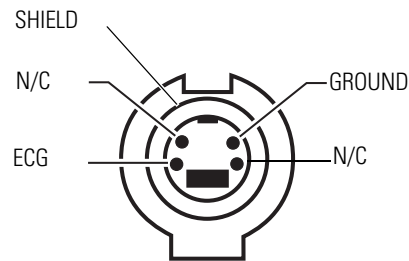

Real-time ECG Output connector
(side-panel view)

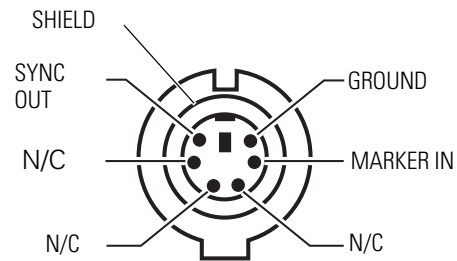

Defib Sync connector
(side-panel view)

Impedance pneumography (RESP)

Characteristic	Specification
Display Characteristics	
Sweep speed	3.13, 6.25, 12.5 mm/sec; user-selectable
Amplitude range	1x, 2x, 4x, 8x, 16x
Performance Characteristics	
Excitation signal characteristics	65 μ A RMS \pm 5% at 63.0 kHz pseudo sine wave
Sensing electrodes	User selectable RA-LA or RA-LL
Base impedance (in addition to 1K resistors in ECG cables)	100 to 1200 ohms is normal monitoring range, approx. 1200-1500 ohms range produces a "NOISY SIGNAL, CHECK ELECTRODES" equipment alert. Above approx. 1500 ohms produces a "RESP FAULT, LEAD FAIL" equipment alert. Thresholds are dependent on ECG cable type.
Impedance dynamic range	20 ohms
Signal bandwidth after detection	0.06 Hz (single pole) to 3.2 Hz (2 pole)
Breath detection threshold	140 milliohms or 2x CVA, whichever is greater
Respiration rate range	Adult/Ped: 0 (apnea), 2 to 150 breaths/min Neonate: 0 (apnea), 3 to 150 breaths/min
Respiration rate accuracy	\pm 2 breaths/min or \pm 2%, whichever is greater
Respiration rate source (RR)	When CO ₂ is active, CO ₂ is the BR source. Otherwise, RESP from ECG is the RR source.
Apnea alarm delay accuracy	+1 second
Resolution	5 seconds
Apnea alarm delay settings	Central apnea only - alarm delay is set by the user Adult/Ped = 6, 10, 15, 20, 25, 30 Neonate = 6, 10, 15, 20 seconds
Cardiovascular artifact rejection (CVA)	Presence of CVA is detected automatically. Breaths will be picked in the presence of CVA unless the Breath Rate is within 5% of the Heart Rate or a sub-multiple of the heart rate.
Motion artifact rejection	not rejected
Obstructive apnea	not detected
Cardiovascular artifact rejection (CVA)	Presence of CVA is detected automatically. Breaths will be picked in the presence of CVA unless the Breath Rate is within 5% of the Heart Rate or a sub-multiple of the heart rate.
Motion artifact rejection	not rejected
Obstructive apnea	not detected

Invasive pressure

Applies only to models 204 and 206.

Characteristic	Specification
Transducer Type	Strain-gauge resistive bridge, or HP quartz (with HP Option). ^a
Transducer Excitation Impedance Range	200 to 2000 Ω
Transducer sensitivity	5 $\mu\text{V}/\text{V}/\text{mmHg}$
Excitation Voltage	4.85V Pulsed dc @ 181 Hz ^b
Connector	ITT-Cannon plug MS3106F-14S-6P Std. Hewlett-Packard compatible 12-pin connector (optional).
Bandwidth	Digital filtered, dc to 20 Hz
Zero Drift	± 1 mmHg without transducer drift
Zero Adjustment	± 200 mmHg including transducer offset
Numeric Accuracy	± 2 mmHg or 2% of reading, whichever is greater, plus transducer error
Pressure range	-30 to 300 mmHg
Pulse range	25 to 250 beats per minute ^c
IBP Alarm Limit Ranges	All patient modes Systolic, Diastolic, Mean -30 to 300 mmHg
Leakage Current	Meets ANSI/AAMI risk (leakage) requirements
Electrosurgery interference suppression	Included in all models

- a. Transducers with 40 $\mu\text{V}/\text{V}/\text{mmHg}$ sensitivity are not compatible.
- b. Duty factor depends on transducer impedance. For 200 to $\sim 900 \Omega$, duty factor is $\approx 11\%$. Above $\sim 900 \Omega$, the duty factor increases to $\approx 91\%$.
- c. At pulse rates exceeding 250 beats per minute, refer to the IBP waveforms on the display or printout to determine systolic and diastolic pressures.

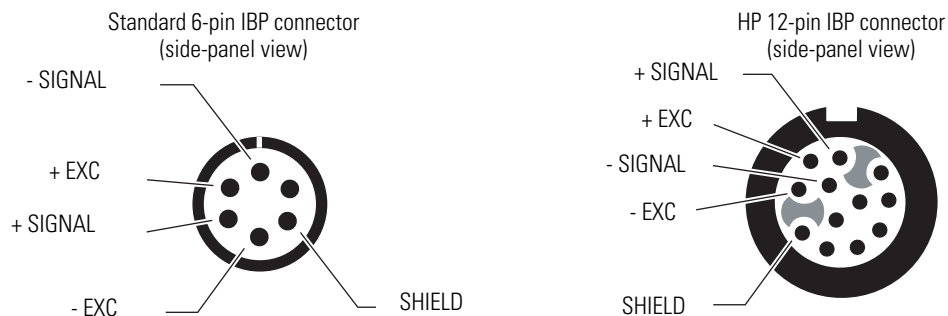

NIBP

Characteristic	Specification
Method	Oscillometric
Control	Automatic and manual measurement control
Auto Intervals	1, 2, 3, 5, 10, 15, 30, and 60 minutes
Turbocuf	Maximum measurements allowable in a 5-minute period
Displayed Pressures	Systolic, Diastolic, and Mean plus on-screen manometer
Systolic Range	Adult: 30 to 260 mmHg Ped: 30 to 160 mmHg Neonate: 25 to 120 mmHg
Diastolic Range	Adult: 20 to 235 mmHg Ped: 15 to 130 mmHg Neonate: 10 to 105 mmHg
Mean Range	Adult: 20 to 255 mmHg Ped: 15 to 140 mmHg Neonate: 10 to 110 mmHg
Static Manometer Accuracy	± 3 mmHg
Minimum Inflation Pressure	Adult: 100 mmHg Ped: 80 mmHg Neonate: 50 mmHg
Maximum Allowable Pressure	Adult: 270 mmHg Ped: 170 mmHg Neonate: 132 mmHg
Default Inflation Pressure	Adult: 160 mmHg Ped: 120 mmHg Neonate: 90 mmHg
Normal Overpressure Limit (results in up to 2 retries)	Adult: 280 mmHg Ped: 200 mmHg Neonate: 141 mmHg
Single Fault Overpressure Limit	Adult: 308 mmHg Ped: 220 mmHg Neonate: 154 mmHg
Leak Rate	After a 1-minute settling period, leak rate is ≤ 4 mm/Hg over a 3-minute period at 270 mm/Hg.
Pulse Rate Range	30 to 220 beats per minute
NIBP Alarm Limit Ranges	Neonate: Systolic 25 to 120 mmHg Diastolic 10 to 105 mmHg Mean 10 to 110 mmHg Pediatric: Systolic 30 to 160 mmHg Diastolic 15 to 130 mmHg Mean 15 to 140 mmHg Adult: Systolic 30 to 260 mmHg Diastolic 20 to 235 mmHg Mean 20 to 255 mmHg
Maximum Determination Time (with retries)	Adult: 4.5 minutes Ped: 4 minutes Neonate: 3 minutes
Maximum Determination Time (no retries)	Adult: 3 minutes Ped: 2 minutes Neonate: 1.5 minutes
Typical Determination Time without Artifact	30 to 45 seconds
Minimum Time between automatic measurements	30 seconds (Auto Mode) 2 seconds (Turbo Mode)
Electrosurgery Interference Suppression	Included in all models: 202EL, 204EL, 206EL
NIBP Performance	Per EN 1060-1, EN 1060-3, and ANSI-AAMI SP10-1992
NIBP Safety	Per IEC 601-2-30

Temperature

Characteristic	Specification										
Range	0° to +50°C; 32° to +122°F										
Displays	T1, T2, and ΔT										
Probes	Compatible with YSI Series 400 and 700 probes. HP side panel only compatible with YSI 400 and has HP connector.										
Units	°C and °F selectable										
Channel Accuracy	<table border="1"> <thead> <tr> <th>Temperature Range</th> <th>Tolerance</th> </tr> </thead> <tbody> <tr> <td>0° to +10°C</td> <td>± 0.2°C</td> </tr> <tr> <td>>10° to +50°C</td> <td>± 0.1°C</td> </tr> <tr> <td>+32° to +50°F</td> <td>± 0.4°F</td> </tr> <tr> <td>>50° to +122°F</td> <td>± 0.2°F</td> </tr> </tbody> </table>	Temperature Range	Tolerance	0° to +10°C	± 0.2°C	>10° to +50°C	± 0.1°C	+32° to +50°F	± 0.4°F	>50° to +122°F	± 0.2°F
Temperature Range	Tolerance										
0° to +10°C	± 0.2°C										
>10° to +50°C	± 0.1°C										
+32° to +50°F	± 0.4°F										
>50° to +122°F	± 0.2°F										
Resolution	0.1°C or °F										
Temperature Alarm Limit Range (T1, T2)	32.0° to 122.0°F 0° to +50.0°C										
Electrosurgery interference suppression	Included in all models: 202EL, 204EL, 206EL										

Pulse oximetry (SpO₂)

Masimo

SpO₂ complies with EN ISO 9919:2005.

Characteristic	Specification
Saturation (% SpO ₂)	
Range	1% to 100%
Resolution	1%
Alarm Limits	52% to 100% (upper) 50% to 98% (lower)
Probe Accuracy (25° to 41° C)	
Adults, Pediatrics: No motion	70% to 100% ± 2 counts 0% to 69% unspecified
Neonates: No motion	70% to 100% ± 3 counts 0% to 69% unspecified
Adults, Pediatrics, Neonates: During Motion ^{a,b}	70% to 100% ± 3 counts 0% to 69% unspecified
Pulse Rate	
Range: No motion	26 to 239 beats per minute, ± 3 counts
Range: During motion ^{a,b}	26 to 239 beats per minute, ± 5 counts
Resolution	1 beat per minute
Alarm Limits	27 to 250 beats per minute (upper) 25 to 248 beats per minute (lower) Note: Any pulse rate above 239 will activate the pulse rate alarm, even if the upper alarm limit is set above 239. If the lower alarm limit is set to 25, a pulse rate of 25 will activate the pulse rate alarm due to the limitation of the displayable numeric range.
Pulse Rate Accuracy	
No Motion	± 3 beats per minute
During Motion ^{a,b}	± 5 beats per minute
Measurement averaging time	8 seconds
Alarm Hold-Off Time Period	10 seconds; resets if the sensor reports levels within limits before 10 seconds elapses
Circuitry	Microprocessor controlled Automatic self-test of oximeter when powered on Automatic setting of default parameters Automatic alarm messages
Electrosurgery interference suppression	Yes
Sensor Compatibility	Compatible only with Masimo sensors listed in the Propaq monitor section of the Welch Allyn <i>Products and Accessories</i> guide (810-0409-XX). For probe/sensor compliance to EN ISO 9919:2005, see the Masimo directions for use.
Sensor LEDs	
RED Wavelength	660 nm (nominal)
INFRARED Wavelength	905 nm (nominal)
Sensor Energies (Radiant Power)	0.13 mW to 0.79 mW at 50 mA pulsed

- a. Motion for adults and pediatrics is defined as rubbing and tapping motions at 2 to 4 Hz at an amplitude of 1 to 2 cm and a non-repetitive motion between 1 to 5 Hz at an amplitude of 2 to 3 cm in induced hypoxia studies in the range of 70-100% SpO₂ against a laboratory co-oximeter and ECG monitor. This variation equals ± 1 standard deviation which encompasses 68% of the population.
- b. Motion for neonates is defined as foot motions at 2 to 4 Hz at an amplitude of 1 to 2 cm against a laboratory co-oximeter and ECG monitor. This variation equals ± 1 standard deviation which encompasses 68% of the population.

Nellcor

SpO₂ complies with EN ISO 9919:2005.

Characteristic	Specification ^a
Saturation (% SpO ₂)	
Range	0% to 100%
Resolution	1%
Alarm Limits ^b	52% to 100% (upper) 50% to 98% (lower)
Probe Accuracy (saturation levels between 70% and 100%, 28° to 42°C)	
Adult/Pediatric	Digit accuracy: ± 2 counts
Neonatal	Digit accuracy: ± 3 counts
Pulse Rate	
Range	25 to 250 beats per minute
Alarm Limits	27 to 250 beats per minute (upper) 25 to 248 beats per minute (lower)
Pulse Rate Accuracy	± 3 beats per minute
Alarm Hold-Off Time Period	10 seconds; resets if the sensor reports levels within limits before 10 seconds elapses
Circuitry	Microprocessor controlled Automatic self-test of oximeter when powered on Automatic setting of default parameters Automatic alarm messages
Electrosurgery interference suppression	Yes
Sensor Compatibility	Compatible only with Nellcor sensors listed in the Propaq monitor section of the Welch Allyn <i>Products and Accessories</i> guide (810-0409-XX). For probe/sensor compliance to EN ISO 9919:2005, see the Nellcor directions for use.
Sensor LEDs	
RED Wavelength	660 nm (nominal)
INFRARED (IR) Wavelength	890 nm (nominal)
Sensor Energies (Radiant Power)	
Electrical Power	52.5 mW max.
Optical Power	15 mW max.
Pulse Rate Accuracy	
No Motion	± 3 beats per minute
During Motion	± 5 beats per minute

- a. When performing SpO₂ monitoring, the monitor SpO₂ channel may not (in rare instances) initially detect a damaged SpO₂ sensor or extension cable (as described in EN ISO9919:2005, Section 51.102), but may simply display a flat line and no numerics. If this occurs, try connecting a new SpO₂ sensor (and extension cable, if needed) and restart the monitor to resume normal monitoring.
- b. Minimum difference between upper and lower alarm limits is 2%.

Capnography (CO₂)

Characteristic	Specification
CO₂ display	
Screen Display	CO ₂ waveform and ETCO ₂ and INCO ₂ (when in alarm) numerics
Numeric Display Ranges	ETCO ₂ 0-99 mmHg, 0-13.2 kPa, 0-23.1% INCO ₂ 8 ^a -25 mmHg, 1.1 ^a -5 kPa, 1.1 ^a -5%
Waveform Scale (Maximum)	0-100 mmHg, 0-14 kPa, 0-14%
Units	mmHg, kPa, %; user-selectable
Sweep Speed	3.13, 6.25, 12.5 mm/sec; user-selectable
Response Modes	Fast 15 sec sampling time period Normal 30 sec sampling time period Slow 45 sec sampling time period
Gas Compensation	OFF CO ₂ value = calculated CO ₂ value; O ₂ > 50%, No N ₂ O CO ₂ value = calculated CO ₂ value x 1.03; N ₂ O > 50% CO ₂ value = calculated CO ₂ value x 0.952
Alarm Limit Ranges	ETCO ₂ 0-99 mmHg, 0-13.2 kPa, 0-13.2% INCO ₂ 2-25 mmHg, 0.2-5 kPa, % (no lower limit)
Resolution	1 mmHg
Accuracy	Mainstream ^b 0-30 mmHg, ± 3 mmHg 31-99 mmHg, ± 10% of value Sidestream ^c 0-30 mmHg, ± 3 mmHg 31-99 mmHg, ± 10% of value
Altitude Error	± 0.4%/1,000 ft (304.8 m)
Breath rate display	
Screen Display	Numeric
Breath rate (BR) source	When CO ₂ is active, CO ₂ is the BR source. Otherwise, RESP from ECG is the RR source.
Units	Breaths/Minute
Range	Adult/Ped0 (apnea), 2 to 150 breaths/min Neonate0 (apnea), 3 to 150 breaths/min
Resolution	± 1 breaths/min
Accuracy	± 1 breaths/min or ± 5%, whichever is greater ^d
Alarm Limits Range	Adult/Ped2 to 150 breaths/min Neonate3 to 150 breaths/min
CO₂ performance	
Specification	Per ISO 21647:2004
Apnea alarms and tickets	
Apnea Ticket	Set to auto print after apnea event and after 1 minute continued apnea
Apnea Alarm Accuracy	± 2 sec
Apnea delay setting	Adult/Ped = 6, 10, 15, 20, 25, 30 seconds Neonate = 6, 10, 15, 20 seconds
Barometric pressure	
Pressure Compensation	Automatic
Operating Range	-2,000 to 15,000 ft (-610 to 4572 m), 817 to 429 mmHg
Screen Display	Numeric (CO ₂ Status Window)
Units	mmHg or kPa
Accuracy	± 3 mmHg or 2.5% of difference from calibration pressure, whichever is greater

a. Lower if in alarm.

b. Based on these airway conditions: sensor 42° airway adapter temperature = 33°C, water vapor pressure = 38 mmHg; standard gas mixture = CO₂ in balance air, fully hydrated at 33°C; barometric pressure = 760 mmHg and flow = 60 ml/min.

c. Based on the following additional airway conditions: Sample line = 7 ft, 0.055 in ID (2.13 m, 1.4 mm ID); Sample flow rate = 175 ml/min; Welch Allyn watertrap (new/unused); Respiratory rate ≤ 50 bpm, stable to ± 3 breaths/min; Inspired/Expired time ratio = 1:2. Barometric pressure = 760 mmHg.

d. For sidestream CO₂, this applies only for BR ≤ 50.

Mainstream CO₂

Characteristic	Specification
Mainstream CO₂ sensor	
Sensor Type	Mainstream
Principle of Operation	Non-dispersive, infrared, single-beam, single path/ wavelength, ratiometric
Warm-up time (CO ₂ sensor and monitor)	45 sec typical, 3 min maximum
Response Time	30 ms typical, 60 ms maximum
Waveform Rise Time	<120 ms to 90% after step change
Calibration	Verify semi-annually, calibrate only as required
Sensor Housing Temperature	42°C nominal
Mainstream CO₂ sensor and cable dimensions and weight	
Sensor Height ^a	1.003 in
Sensor Width ^a	1.036 in
Sensor Depth ^a	0.78 in
Sensor Weight ^a	< .39 oz
Cable Length	10 ft (3.05 m) nominal
Mainstream CO₂ airway adapter	
Type	Per ISO 3040, single-use
Size	15 mm ID, (meets ISO specifications)
Material	clear polycarbonate, with sapphire windows
Added Deadspace	< 6cc (.37 cubic inches) for adult model, <0.6 cc (.037 cubic inches) for low deadspace model
Mainstream CO₂ sensor environmental specifications	
Operating Ambient Temperature	10° to 40°C
Storage Temperature	-20° to 60°C
Operating Altitude	-2,000 to 15,000 ft (-610 to 4,572 m), 817 to 429 mmHg
Storage Altitude	-2,000 to 40,000 ft (-610 to 12,192 m), 817 to 141 mmHg
Operating and Storage Humidity	0% to 95%, noncondensing
Shock	100 g for 4 msec
Vibration	5-35 Hz, 0.015 in peak-to-peak, 35-100 Hz, 1 g acceleration
Drop	36 inches free fall to floor (tile over concrete, one drop each face, one drop each edge/corner)

a. not including cable

Sidestream CO₂

Characteristic	Specification
Sensor Type	Sidestream, internal
Principle of Operation	Non-dispersive, infrared, single-beam, single path/ wavelength, ratiometric
Operating Ambient Temperature	5° to 40°C
Startup Time	30 seconds typical, 3 minutes maximum
Rise Time	240 ms (10% to 90%) at 175 ml/min
Delay Time	1.12 seconds maximum ^a
Total System Response Time	1.36 seconds maximum (Rise Time and Delay Time)
Calibration	Verify semi-annually, calibrate only as required
Sampling Chamber	Internal (replaceable by service technician)
Pneumatic and Exhaust System	Integral
Barometric Pressure Compensation	Automatic
BTPS, ATPS, STPD ^b	CO ₂ value = calculated CO ₂ value x 0.977
Sampling Line	7-foot sampling line, ID 0.055 in (1.4 mm), for use with disposable single-use cannula (CO ₂ only or CO ₂ sampling/O ₂ delivery)
Watertrap	Disposable single-use
Flow Rate	90 or 175 ml/min, user-selectable

- a. Based on the following additional airway conditions: Sample line = 7 ft, 0.055 in ID (2.13 m, 1.4 mm ID); Sample flow rate = 175 ml/min; Welch Allyn watertrap (new/unused).
- b. BTPS (Body Temperature and Pressure, Saturated), ATPS (Ambient Temperature and Pressure, Saturated), STPD (Standard Temperature and Pressure, Dry).

Alarms

Characteristic	Specification
Indicators	Flashing red alarm bell light: patient alarm(s) Continuously on red alarm bell light: patient alarm silenced or suspended Flashing yellow crossed-alarm light: equipment alert Continuously on yellow crossed-alarm light: one or more patient alarm limit(s) off
Tone Frequency	900 Hertz
Tone Patterns	Apnea: 1 second on, 1 second off Patient alarm: 1 second on, 2 seconds off Equipment alert: 1 second on, 4 seconds off
Selectable Tone Volume	Low, Medium, High
Limits	Settable on all parameters
Control	Automatic preset or manual settings
Alarm on Tachycardias	Most tachycardias will alarm in less than 8 seconds. These include AAMI 3.1.2.1 part f. waveforms. Certain multifocal tachycardias may initially alarm as "low rate."
Apnea delay setting	Adult/Ped = 6, 10, 15, 20, 25, 30 seconds Neonate = 6, 10, 15, 20 seconds
Alarm Holdoff Time Period ^a	HR/PR = 3 seconds (except NIBP PR) SpO ₂ = 10 seconds RR/BR = 5 seconds
Audio Alarm Holdoff with Acuity	When a Propaq Encore in Adult or Pediatric Mode is connected to an Acuity System, the audio alarms at the bedside Propaq can be delayed up to 4 minutes and 15 seconds. The delay time is selected in Acuity software at the time of Acuity installation. Visual alarm indications are not delayed.

a. Alarm holdoff time period is reset if the vital sign returns to acceptable limits before an alarm occurs.

Trends

Characteristic	Specification ^a
Model 202 Parameters	NIBP, T1, T2, ΔT, HR (heart rate/pulse rate), SpO ₂ , End-tidal CO ₂ , Inspired CO ₂ , Breath Rate
Model 204 Parameters	NIBP, P1, T1, T2, ΔT, HR (heart rate/pulse rate), SpO ₂ , End-tidal CO ₂ , Inspired CO ₂ , Breath Rate
Model 206 Parameters	NIBP, P1, P2, T1, T2, ΔT, HR (heart rate/pulse rate), SpO ₂ , End-tidal CO ₂ , Inspired CO ₂ , Breath Rate
Duration	5 hours for non-NIBP trends (up to 150 readings) A maximum of 128 readings (up to 8 hours) for NIBP trends
Resolution	All channels except NIBP sample data at 2-minute intervals For NIBP trends, a new entry is placed in the table each time an NIBP determination is made.

a. Assumes SpO₂ and CO₂ functions are present.

Display

Characteristic	Specification
Matrix	552 x 256 pixels EL display
Active Viewing Area	145.75 mm x 67.56 mm
Pixel Size	0.203 mm x 0.203 mm
Pixel Pitch	0.264 mm x 0.264 mm
Character Height	Large: 11.03 mm (0.434 in) Medium: 7.34 mm (0.289 in) Small: 3.64 mm (0.143 in)
Viewing Angle	>160° Horizontal and Vertical
Contrast Ratio	>45 ("On" pixel luminance/"Off" pixel luminance)
Display Color	Amber
Display Background Color	Black
"On" Pixel Luminance	>9.0 fL (area of amber pixel; includes protective window)
"Off" Pixel Luminance	<0.2 fL (black pixel)
Refresh Rate	109 Hz

Monitor (environmental)



Caution The monitor may not meet performance specifications if it is not used or stored within these environmental specifications.

Characteristic	Specification
Operating Temperature	0° to 40° C
Shipping and Storage Temperature	-20° to 60° C
Operating Altitude	-2,000 to 15,000 ft (-610 to 4,572 m)
Shipping and Storage Altitude	-2,000 to 40,000 ft (-610 to 12,192 m)
Operating Relative Humidity	15% to 95%, noncondensing per MIL STD 810E, Procedure 1-natural
Shipping and Storage Relative Humidity	15% to 95%, noncondensing per MIL STD 810E, Procedure 1-natural
Shock	102 g
Vibration, Random	0.02g ² /Hz from 10 to 500 Hz, ramping down to 0.002g ² /Hz at 2000 Hz. Operating 1 hour per axis, 3 hours per test. Designed to meet RTCA DO-160C, Category C.
Designed to meet EN ISO 9919:2005 Designed to meet EN ISO 21647:2004	Clause 21.102b) 10Hz to 100Hz: 5.0 (m/s ²) ² /Hz, 100Hz to 200Hz at -7 db per octave; 200 Hz to 2000 Hz: 1.0 (m/s ²) ² /Hz; duration: 30 min per perpendicular axis (3 total)
Vibration, Sinusoidal	0.10 peak to peak inches 5 to 17 Hz, sloping to 0.01 peak to peak inches at 55 Hz, then sloping to 0.0001 peak to peak inches at 2000 Hz. Operating 1 hour per axis, 3 hours per test. Designed to meet RTCA DO-160C, Category N.
Degree of protection against ingress for monitors <i>without</i> CO ₂ or printer options	IPX1 rating, drip proof per EN60529: 1991

Monitor (physical)

Characteristic	Specification
Protection classifications, all configurations ^a	
Type of Protection against Electric Shock—Power Adapter	Power adapter class 1
Type of Protection against Electric Shock—Monitor (when connected to power adapter or powered by internal battery)	Protective earth not available in monitor. Monitor designed and tested to meet Double Insulation Requirement.
Degree of Protection Against Electric Shock, for Parts Applied to Patients	See monitor labels
Recovery time following defibrillator discharge	Less than or equal to 10 seconds
Electrosurgery interference suppression	Suitable for use in the presence of electrosurgery
Method of Disinfection	Not suitable for autoclaving ^b
Flammable Anesthetics	Not suitable for use with flammable anesthetics
Monitor only	
Height	6.65 in (16.9 cm)
Width	8.25 in (20.9 cm)
Depth	5.10 in (12.9 cm)
Weight	6.25 lb (2.8 kg)
Monitor with SpO₂ module	
Height	6.65 in (16.9 cm)
Width	8.25 in (20.9 cm)
Depth	7.50 in (19.10 cm)
Weight	9.12 lb (4.10 kg)
Monitor with expansion module (Printer / SpO₂ / CO₂)	
Height	9.65 in (24.5 cm)
Width	8.25 in (20.9 cm)
Depth	7.56 in (19.2 cm)
Weight with Printer, SpO ₂ , and CO ₂	13.5 lb (6.1 kg)

a. Per EN 60601-1 unless otherwise stated.

b. See Chapter 7 for cleaning instructions.

Printer

Characteristic	Specification
Operation	
Operating Modes	Continuous, Snapshot, Freeze Print, Auto Print, Auto Trend, Tabular Trend, Alarm Print, NIBP Ticket, Apnea Ticket, OxyCRG, OxyCRG on Alarm
Auto Print Intervals	15 min, 30 min, 1 hour, 2 hours, 4 hours
Auto Trend Shifts	Once every 4 hours
Number of Waveforms	Up to three: ECG, P1, P2, SpO ₂ , CO ₂ , RESP
Grid	5 mm and 1 mm gradations
Annotation	Date, Time, Print Mode, Speed, Heart Rate, Systolic, Diastolic, Mean, SpO ₂ , Breath Rate, ETCO ₂ , INCO ₂ , Temperature, ΔT, Pacer Status, Company Logo, ECG Bandwidth, Patient Mode, scale factors for all traces and, if Acuity is connected, patient name and identification.
Printing Speeds	6.25, 12.5, 25.0 mm/sec, simulated 6.25 mm/sec for CO ₂ and RESP in Snapshot mode
Printer mechanism	
Printing Method	Thermally sensitive dot method
Dot structure	320 dots per line
Printing width	53 mm
Horizontal Dot Pitch	0.165 mm, 6 dots/mm
Vertical Dot Pitch	0.165 mm
Paper Feed Method	Friction Feed
Paper Feed Precision	± 2% @ 25° C and 60% Relative Humidity
Paper Width	60 mm
Reliability	30 million pulses/dot
Environmental	
Monitor/expansion module	
Operating Temperature	+5° to 40° C
Shipping and Storage Temperature	-20° to 60° C
Operating Relative Humidity	35% to 85% noncondensing
Shipping, Storage Relative Humidity	15% to 90% noncondensing
Operating Altitude	-2,000 to 15,000 ft (-610 to 4,572 m)
Shipping and Storage Altitude	-2,000 to 40,000 ft (-610 to 12,192 m)
Shock	102 g for 6 msec
Vibration, Random	0.02g ² /Hz from 10 to 500 Hz, ramping down to 0.002g ² /Hz at 2000 Hz. Operating 1 hour per axis, 3 hours per test. Designed to meet RTCA DO-160C, Category C.
Designed to meet EN ISO 9919:2005 Designed to meet EN ISO 21647:2004	Clause 21.102b) 10Hz to 100Hz: 5.0 (m/s ²) ² /Hz, 100Hz to 200Hz at -7 db per octave; 200 Hz to 2000 Hz: 1.0 (m/s ²) ² /Hz; duration: 30 min per perpendicular axis (3 total)
Electromagnetic Compatibility (EMC)	Per IEC 601-1-2, which is a collateral standard of IEC 601-1, for electromagnetic compatibility.
Paper	
Short-term Storage Environment (up to 7 days)	-20 to 40°C; 5% to 80% noncondensing
Long-term Storage Environment (up to 5 years)	25°C (optimal), 65% noncondensing

Power

Characteristic	Specification
Mode of Operation	Continuous
Battery Pack Type	Sealed, gel-type lead acid
Battery Pack Capacity	Monitor only: 8 volts, 3 Ampere-Hours; Monitor with Expansion Modules: 8 volts, 6 Ampere-Hours
Battery Recharger Circuitry	Internal, powered by external power adapter
DC Input Power Required	12 to 28 Volts, 25 Watts
Input Fuse Rating	3A/250V, Type 2AG (0.57x 0.177 in)
Operating Times on Battery	
Monitor only	2 hours
Monitor and SpO ₂ (Baqpaq)	5 hours
Monitor with Expansion Module with printer, SpO ₂ and CO ₂ Options	3 hours
Battery Recharge Time with instrument on	Range of 8 hours to 12 hours typical, depending upon product configuration
Battery Recharge Time with instrument off	Range of 6 hours to 8 hours depending upon product configuration
Recharge time until monitor is usable, starting with discharged but non-faulty battery	≤ 2 minutes typically (longer time required before NIBP, printer, and CO ₂ are available)

Power adapters

Characteristic	Specification
Protection classifications, all adapters^a	
Type of Protection Against Electric Shock	Class I, (Protectively Earthed)
Degree of Protection Against Harmful Ingress of Water	For ordinary, indoor locations only.
Method of Disinfection	Not suitable for autoclaving ^b
Flammable Anesthetics	Not suitable for use with flammable anesthetics
Environmental specifications, all adapters	
Operating Temperature	0° to 50° C
Shipping and Storage Temperature	-20° to 60° C
Operating Altitude	-2,000 to 15,000 feet (-610 to 4,572 m)
Shipping and Storage Altitude	-2,000 to 40,000 feet (-610 to 12,192 m)
Operating Relative Humidity	15% to 95%, noncondensing
Shipping, Storage Relative Humidity	15% to 95%, noncondensing
Shock	50 g
Vibration	Random Vibration, 0.02g ² /Hz from 10 to 300 Hz, ramping down to 0.002g ² /Hz at 500 Hz. Operating 1 hour per axis, 3 hours per test.
Water Resistance	For ordinary, indoor locations only.

- a. Per EN 60601-1 unless otherwise stated.
 b. See Chapter 8 for cleaning instructions.

Characteristic	Specification
Universal power adapter, 503-0054-00, 503-0093-XX	
Length	5.0 in (12.7 cm)
Width	3.6 in (9.1 cm)
Height	3.1 in (7.9 cm)
Weight	3.1 lb (1.4 kg)
Rated Input	100V-120V ac, 500 mA, 50/60 Hz
Rated Fuses	T800 mA/250V, Time-Delay, 5x20mm
Rated Output (Continuous)	16-24V dc, 25 VA
Additional Features	Detachable power cord, pilot light
Universal power adapter, 503-0054-01, 503-0092-XX	
Length	5.0 in (12.7 cm)
Width	3.6 in (9.1 cm)
Height	3.1 in (7.9 cm)
Weight	3.1 lb (1.4 kg)
Rated Input	200V-240V ac, 250 mA, 50/60 Hz
Rated Fuses	T400 mA/250V, Time-Delay, 5 x 20mm
Rated Output (Continuous)	16-24V dc, 25 VA
Additional Features	Detachable power cord, pilot light

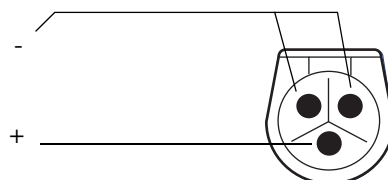

Power Adapter
connector

Factory default settings

Characteristic	Specification
Date ^a	MO/DA/YR, DA.MO.YR, or YR/MO/DA
Decimal ^a	. (Period)
HR/PR Sweep	25 mm/sec
RR/BR Sweep	6.25 mm/sec
Alarm Tone	MEDIUM
HR/PR TONE	LOW
HR/PR SOURCE	ECG
RR/BR Source	CO ₂ if ON or ECG (if CO ₂ OFF)
Patient Mode	Adult
ECG Bandwidth	Monitor
ECG Size	1 mV/cm
ECG Lead	II
ECG Filter ^a	60 Hz
ECG Pacer	ON
RESP size	2X
RESP lead	Ld2
RESP sweep	6.25 mm/sec
RESP ON/OFF	ON
RESP window	ON
IBP Range	0 to 180 mmHg
IBP Rescale	0 to 140 mmHg
IBP Mode	RESCALE
Invasive Pressure Formats	Label dependent
NIBP Mode	MANUAL
NIBP Auto Time	15 min
SpO ₂ SIZE	2x
SpO ₂ C-LOCK	OFF
SpO ₂ Response	NORMAL
TEMP F/C ^a	Celsius
CO ₂ Range	0 to 60 mmHg
CO ₂ Sweep	6.25 mm/sec
CO ₂ Response	NORMAL
CO ₂ Units ^a	mmHg
CO ₂ Gas Compensation	OFF
Sidestream CO ₂ Flow Rate	Adult: 90 ml/minute Ped: 90 ml/minute Neonate: 90 ml/minute (The flow rate cannot be programmed to a different value in a Custom Patient Mode. See Custom Patient Modes.)
Display Wave Select	All waves are on except NIBP
Trend Group	NIBP
Alarm Limits	All are ON except P2
HR Limits	Adult: 50, 120 beats per minute Ped: 50, 150 beats per minute Neonate: 100, 200 beats per minute
NIBP Limits - Systolic	Adult: 75, 220 mmHg Ped: 75, 145 mmHg Neonate: 50, 100 mmHg
NIBP Limits - Diastolic	Adult: 35, 110 mmHg Ped: 35, 100 mmHg Neonate: 30, 70 mmHg
NIBP Limits - Mean	Adult: 50, 120 mmHg Ped: 50, 110 mmHg Neonate: 35, 80 mmHg
P1, P2 Limits - Systolic	Adult: 75, 220 mmHg Ped: 75, 145 mmHg Neonate: 50, 100 mmHg

Characteristic	Specification
P1, P2 Limits - Diastolic	Adult: 35, 110 mmHg Ped: 35, 100 mmHg Neonate: 30, 70 mmHg
P1, P2 Limits - Mean	Adult: 50, 120 mmHg Ped: 50, 110 mmHg Neonate: 35, 80 mmHg
SpO ₂ Limits	Adult: 85%, 100% Ped: 85%, 100% Neonate: 80%, 95%
RR/BR	Adult: 5, 30 BrM Ped: 10, 45 BrM Neonate: 10, 60 BrM
TEMP Limits	35.0°, 37.8° C
ΔT Limits	0.0°, 2.8° C
ETCO ₂ Limits	25, 60 mmHg (3, 8 for % and kPa)
INCO ₂ Limits	N/A, 5 mmHg (0.7 for % and kPa)
Apnea Delay	Adult/Ped: 20 seconds Neonate: 15 seconds
PRINTER SETTINGS	
Printer Alarm Print	OFF
Printer Auto Print	OFF
Printer NIBP Ticket	OFF
Printer Apnea Ticket	ON
Printer Print Speed	25 mm/sec
Printer Auto Trend	OFF
Printer Trend Selections	NIBP and P1 = ON; all others = OFF
Printer OxyCRG on Alarm	OFF

- a. Any time you change the Date, Filter, Temp F/C, Decimal, or CO₂ Units setting, the new setting also becomes the powerup default setting.

In-service simulated values

Channel	Display	Initial value	Alternate value
ECG	Waveform	Normal sinus rhythm, 1mV, Lead II	Normal sinus rhythm
ECG	Heart Rate	80 beats per minute	125 beats per minute
RESP	Respiration Rate	12 breaths/minute	31 breaths/minute
P1	Waveform	Arterial	Same as Initial Value
P1	Pulse Rate	80 pulses per min	125 pulses per min
P1	Systolic	121 mmHg	120 mmHg
P1	Diastolic	79 mmHg	85 mmHg
P1	Mean	96 mmHg	103 mmHg
P2	Waveform	Pulmonary Artery	Same as Initial Value
P2	Pulse Rate	80 pulses per min	125 pulses per min
P2	Systolic	25 mmHg	25 mmHg
P2	Diastolic	9 mmHg	12 mmHg
P2	Mean	15 mmHg	18 mmHg
NIBP	Mode	Manual (Auto cancels in-service)	Same as Initial Value
NIBP	Numerics	Actual values from patient	Actual values from patient
T1	Numeric	37.0° C	39.1° C
T2	Numeric	36.4° C	37.4° C
ΔT	Numeric	0.6° C	1.7° C
SpO ₂	Waveform	Normal, 2x	Same as Initial Value
SpO ₂	Rate	80 pulses per min	125 pulses per min
SpO ₂	Numeric	97%	88%
CO ₂	Waveform	Normal	Hyperventilating
CO ₂	ETCO ₂ Numeric	38 mmHg	60 mmHg
CO ₂	INCO ₂ Numeric	0 mmHg	8 mmHg
CO ₂	Breath Rate	12 breaths/minute	31 breaths/minute

EMC compliance

This device complies with part 15 of the FCC Rules. Operation is subject to the following two conditions:

- This device may not cause harmful interference.
- This device must accept any interference received, including interference that may cause undesired operation.

Special precautions concerning electromagnetic compatibility (EMC) must be taken for all medical electrical equipment. The Propaq Encore complies with IEC EN 60601-1-2:2001.

- All medical electrical equipment must be installed and put into service in accordance with the EMC information provided in this document and *Propaq Encore Directions for Use* or *Propaq Encore Reference Guide*.
- Portable and mobile RF communications equipment can affect the behavior of medical electrical equipment.

Propaq Encore monitors comply with all applicable and required standards for electromagnetic interference.

- It does not normally affect nearby equipment and devices.
- It is not normally affected by nearby equipment and devices.
- It is safe to operate the monitor in the presence of high-frequency surgical equipment.
- However, it is good practice to avoid using the monitor in extremely close proximity to other equipment.

Propaq Encore Monitor: Guidance and Manufacturer's Declaration—Electromagnetic Emissions

The Propaq Encore monitor is intended for use in the electromagnetic environment specified below. The customer or the user of the monitor should assure that it is used in such an environment.

Emissions Test	Compliance	Electromagnetic Environment—Guidance
RF emissions CISPR 11	Group 1	The monitor uses RF energy only for its internal function. Therefore, its RF emissions are very low and are not likely to cause any interference in nearby electronic equipment.
RF emissions CISPR 11	Class B	The monitor is suitable for use in all establishments, including domestic establishments and those directly connected to the public low-voltage power supply network that supplies buildings used for domestic purposes.
Harmonic emissions IEC 61000-3-2	Class A	
Voltage fluctuations/flicker emissions IEC 61000-3-3	Complies	

Propaq Encore Monitor: Guidance and Manufacturer's Declaration—Electromagnetic Immunity

The Propaq Encore monitor is intended for use in the electromagnetic environment specified below. The customer or the user of the monitor should assure that it is used in such an environment.

Immunity Test	IEC 60601 Test Level	Compliance Level	Electromagnetic Environment—Guidance
Electrostatic discharge (ESD) IEC 61000-4-2	±6 kV contact ±8 kV air	±6 kV contact ±8 kV air	Floors should be wood, concrete, or ceramic tile. If floors are covered with synthetic material, the relative humidity should be at least 30%.
Electrical fast transient/burst IEC 61000-4-4	±2 kV for power supply lines ±1 kV for input/output lines	±2 kV for power supply lines ±1 kV for input/output lines	Mains power quality should be that of a typical commercial or hospital environment.
Surge IEC 61000-4-5	±1 kV differential mode ±2 kV common mode	±1 kV differential mode ±2 kV common mode	Mains power quality should be that of a typical commercial or hospital environment.
Voltage dips, short interruptions, and voltage variations on power-supply input lines IEC 61000-4-11	<5% U_t (>95% dip in U_t) for 0.5 cycle 40% U_t (60% dip in U_t) for 5 cycles 70% U_t (30% dip in U_t) for 25 cycles <5% U_t (>95% dip in U_t) for 5 sec	<5% U_t (>95% dip in U_t) for 0.5 cycle 40% U_t (60% dip in U_t) for 5 cycles 70% U_t (30% dip in U_t) for 25 cycles <5% U_t (>95% dip in U_t) for 5 sec	Mains power quality should be that of a typical commercial or hospital environment. If the user of the monitor requires continued operation during power mains interruption, it is recommended that the monitor be powered from an uninterruptible power supply or a battery.
Power frequency (50/60 Hz) magnetic field IEC 61000-4-8	3 A/m	3 A/m	Power frequency magnetic fields should be at levels characteristic of a typical location in a typical commercial or hospital environment.
Note	U_t is the AC mains voltage prior to application of the test level.		

Propaq Encore Monitor: Guidance and Manufacturer's Declaration—Electromagnetic Immunity

The Propaq Encore monitor is intended for use in the electromagnetic environment specified below. The customer or the user of the monitor should assure that it is used in such an environment.

Immunity Test	IEC 60601 Test Level	Compliance Level	Electromagnetic Environment—Guidance Level
			Portable and mobile RF communications equipment should be used no closer to any part of the monitor, including cables, than the recommended separation distance calculated from the equation applicable to the frequency of the transmitter.
			Recommended Separation Distance
Conducted RF IEC 61000-4-6	3 V _{rms} 150 kHz to 80 MHz 2Hz AM	3 V _{rms}	$d = 1.2 \sqrt{P}$
Radiated RF IEC 61000-4-3	3 V/m 80 MHz to 2.5 GHz 2Hz AM	3 V/m	$d = 1.2 \sqrt{P}$ 80 MHz to 800 MHz $d = 2.3 \sqrt{P}$ 800 MHz to 2.5 GHz
			where P is the maximum output power rating of the transmitter in watts according to the transmitter manufacturer and d is the recommended separation distance in meters. Field strengths from fixed RF transmitters, as determined by an electromagnetic site survey ^a , should be less than the compliance level in each frequency range ^b . Interference might occur in the vicinity of equipment marked with the following symbol: 
EN ISO9919	20 V/m. 1 kHz AM	20 V/m	Intended for use during patient transport outside the healthcare facility
EN ISO21647	20 V/m. 1 kHz AM	20 V/m	Intended for use during patient transport outside the healthcare facility
Note 1	At 80 MHz and 800 MHz, the higher frequency range applies.		
Note 2	These guidelines might not apply in all situations. Electromagnetic propagation is affected by absorption and reflection from structures, objects and people.		
a	Field strengths from fixed transmitters, such as base stations for radio (cellular/cordless) telephones and land mobile radios, amateur radio, AM and FM radio broadcast and TV broadcast cannot be predicted theoretically with accuracy. To assess the electromagnetic environment due to fixed RF transmitters, an electromagnetic site survey should be considered. If the measured field strength in the location in which the monitor is used exceeds the applicable RF compliance level above, the monitor should be observed to verify normal operation. If abnormal performance is observed, additional measures might be necessary, such as reorienting or relocating the monitor.		
b	Over the frequency range 150 kHz to 80 MHz, field strengths should be less than 3 V/m.		

Recommended Separation Distances Between Portable and Mobile RF Communications Equipment and the Propaq Encore Monitor

The Propaq Encore monitor is intended for use in an electromagnetic environment in which radiated RF disturbances are controlled. The customer or the user of the monitor can help prevent electromagnetic interference by maintaining a minimum distance between portable and mobile RF communications equipment (transmitters) and the monitor as recommended below, according to the maximum output power of the communications equipment.

Rated Maximum Output Power of Transmitter W	Separation Distance According to Frequency of Transmitter m		
	150 kHz to 80 MHz $d = 1.2 \sqrt{P}$	80 MHz to 800 MHz $d = 1.2 \sqrt{P}$	800 MHz to 2.5 GHz $d = 2.3 \sqrt{P}$
0.01	0.12	0.12	0.23
0.1	0.38	0.38	0.73
1	1.2	1.2	2.3
10	3.8	3.8	7.3
100	12	12	23

For transmitters rated at a maximum output power not listed above, the recommended separation distance d in meters (m) can be estimated using the equation applicable to the frequency of the transmitter, where P is the maximum output power rating of the transmitter in watts (w) according to the transmitter manufacturer.

Note 1 At 80 MHz and 800 MHz, the separation distance for the higher frequency range applies.

Note 2 These guidelines might not apply in all situations. Electromagnetic propagation is affected by absorption and reflection from structures, objects and people.

Glossary

ΔT. Difference temperature. The difference between T1 and T2.

AAMI. Association for the Advancement of Medical Instrumentation (United States of America).

AC Power Adapter. The device that plugs into the 12-28V dc receptacle on the Propaq Encore's side panel to allow operation and battery charging from ac mains.

Acuity. Welch Allyn's trade name for its central station patient monitoring system.

Altimeter. A sensor, internal to the Propaq Encore, that measures absolute atmospheric pressure, and is used to correct CO₂ numerics for varying altitudes.

ANSI. American National Standards Institute

Apnea. Condition of no respiration occurring during a prescribed time interval.

ART. Arterial (label for an invasive blood-pressure channel).

Arterial Blood Gas Measurements. Laboratory value reporting acid-base, oxygenation and ventilation status.

Artifact. An unwanted disturbance to or by the patient or attached sensors that adds errors (usually erratic) to the measured parameters, e.g., muscle motion or shivering, electrical interference, vibration of the cuff, etc.

Auto Interval. The interval at which NIBP measurements are initiated when operating in the automatic mode.

Bell. The symbol that appears in a window to indicate alarm limits status. If alarm limits have been set, a bell appears.

BP. Blood pressure

bpm. Beats per minute

Blood Pressure Numerics Windows. The two larger windows below the heart rate. These windows can display invasive pressures and NIBP pressures.

BR. Breath rate, expressed in units per minute or 1/min. BR is derived from CO₂. See also RR.

Buttons. The five buttons along the bottom-front of the Propaq Encore. A menu appears above each button identifying what each button will do when pressed.

Capnogram. Hard copy of the ETCO₂ waveform over time.

Capnometer. Analyzer used to measure CO₂, specifically ETCO₂.

Channel. See Patient Channel.

C-Lock. A processing scheme used in SpO₂ that uses QRS timing to improve the noise tolerance of SpO₂ measurements.

CO₂. A patient channel indicating the by-product of respiration, carbon dioxide, which is exhaled by the lungs.

Configuration. The patient channels included with each Propaq Encore model. A table in Chapter 1 lists the configuration of each Propaq Encore model.

Cursor. The highlighted block in a status window that indicates the selection you make by pressing the NEXT button.

CVA. Cardiovascular artifact.

CVP. Central venous pressure (label for an invasive blood pressure channel).

DC Offset. The DC voltage difference between ECG electrodes. DC offset is caused by using dried out electrodes or electrodes of dissimilar metal types.

Difference Temperature. The difference between T1 and T2. Also called delta T (ΔT).

Digital Filter. A computer program in the Propaq Encore that removes unwanted noise that can be induced into the ECG signal from ac mains.

EL (Electroluminescent) Display. The display screen used in the Propaq Encore.

EMI. An acronym for Electromagnetic Interference.

Endotracheal Tube. Plastic breathing tube placed into the patient's windpipe.

Equipment Alert. Occurs when the Propaq Encore detects an equipment condition requiring operator assistance. A message describing the condition is displayed.

Equipment Alert Window. The window that appears during an equipment alert.

Error Message. The message that appears when the monitor detects a malfunction requiring factory service.

Error Message Window. The window that appears when the monitor detects a malfunction requiring factory service. This window contains error messages and numbers.

Error Number. The number that identifies a problem encountered during operation.

ESD. An acronym for Electrostatic Discharge (from static electricity).

ESIS. An acronym for Electrosurgery Interference Suppression.

ETCO₂. An acronym for end-tidal CO₂. Amount of CO₂ breathed out at the end of an exhalation.

Factory Default Settings. The current values for all Propaq Encore settable functions when the monitor was shipped from the factory.

Freeze. The action taken by the FREEZE button to stop the display. If three waveforms are displayed, all waveforms are frozen. If less than three waveforms are displayed, the current waveforms are frozen and the top waveform is also shown in real-time. See also Unfreeze.

Gas Compensation. A correction factor required to obtain accurate CO₂ readings when elevated levels of O₂ or N₂O are present in respired gases.

Heart Rate Source. See Heart Rate/Pulse Rate Source.

Heart Rate/Pulse Rate. The heart rate derived from the heart rate/pulse rate source and expressed in units per minute or 1/min. See also Heart Rate/Pulse Rate Source.

Heart Rate/Pulse Rate Source. The source from which heart rate/pulse rate is derived. This source can be ECG, any pressure, including NIBP, or SpO₂. When the monitor is first turned on, the Propaq Encore determines the most likely source for heart rate: ECG (first), P1 (second), SpO₂ (third), P2 (fourth), and NIBP (last).

Highlight. The method of identifying a selected item on the display. Highlighted selections appear as light characters on a dark background or dark characters on a light background. See also Cursor.

HR. An acronym for heart rate and expressed in units per minute or 1/min. This is displayed when the heart rate/pulse rate source is ECG.

ICP. Intracranial pressure (label for an invasive blood pressure channel).

Impedance Pneumography. A method of detecting respiratory effort by measuring the AC impedance between selected ECG leads.

INCO₂. An acronym for inspired CO₂. The amount of CO₂ measured during inhalation.

In-service Mode. A user training aid built into all Propaq Encores that provides simulated signals for all patient parameters so that function of the display, alarms, and printer can be explored easily. The in-service mode is activated by the INSERT button.

Invasive Pressure Label. The two or three-character label that appears in the Invasive Pressure Numerics Window identifying the source of blood pressure.

Labels. The names appearing above the buttons.

Mainstream. A respiratory CO₂ measurement technique which uses a noninvasive sensor located at the endotracheal tube. This technique avoids signal delays and fluid problems associated with other techniques.

Menu. A group of labels above the bottom front row of buttons on a Propaq Encore.

NIBP Status Window. The window that appears when the NIBP button is pressed. This window displays NIBP information.

Numerics. The numbers that appear along the top and right side of the display for heart rate, blood pressure, temperature, etc.

OxyCRG. An oxygen cardiorespirogram, a graph showing heart rate, SpO₂, and a condensed respiratory waveform.

P1. A generic label for invasive pressure channel one.

P2. A generic label for invasive pressure channel two.

PA. Pulmonary artery (label for an invasive blood pressure channel).

Parameter. See Vital Sign Parameter.

Patient Alarm. The condition that exists when a vital sign parameter numeric violates an alarm limit.

Patient Channel. ECG, P1, P2, T1, T2, SpO₂, CO₂, NIBP and RESP.

Patient Mode. Selects Adult, Pediatric, or Neonatal mode settings for the monitor. These settings determine default alarm limits, maximum cuff inflation pressure, and other internal settings.

Pinout. The signal descriptions for each pin of a connector.

Polarization. The activity that occurs when dissimilar metals between ECG electrodes and leads meet. This can cause dc offset and other signal problems.

PR. Pulse rate, expressed in units per minute or 1/min. This is displayed when the heart rate/pulse rate source is from a pressure channel or SpO₂.

Pulse Rate. The heart rate determined from either a pressure channel, SpO₂, or NIBP; expressed in units per minute or 1/min.

Pushbutton. See Buttons.

Range Mode. The method used in invasive pressure display to show two waveforms against the same pressure scale.

Rescale Mode. The method used in invasive pressure display to show each waveform against its own scale. The scale is automatically selected for best viewing of the entire waveform.

Respiration. The exchange of oxygen and carbon dioxide in the lungs and with the cells of the body.

RR. Respiration rate, a measure of the frequency of respiration. See also Impedance Pneumography.

Sensors. The electrodes, transducers, probes, etc. used to obtain patient information.

Serial Number. The unique number assigned to the monitor. It is located on the rear panel label.

Sidestream. A respiratory CO₂ measurement technique which can be used for intubated or non-intubated patients.

Software Version Number. The unique number assigned to the version of the Propaq Encore's internal programming. This number appears in the Startup window.

SpO₂. The standard term assigned to measuring oxygen saturation using a pulse oximeter. The SpO₂ patient channel noninvasively measures oxygen saturation of arteriolar hemoglobin at a peripheral measurement site, such as a finger, toe, or the bridge of the nose.

Startup Window. The information window that appears while the monitor performs its powerup test just after you turn on the Propaq Encore. This information includes the Propaq Encore model number and software version number.

Status Window. A window that appears and contains information about the Propaq Encore.

SYNC. Synchronization. Two uses apply:

A digital output pulse from the right side panel that starts within 35 msec of the peak of a QRS complex and is used for cardioversion.

A message in the SpO₂ display indicating successful C-Lock.

Temporary Patient Alarm. An alarm limit violation that occurred and was corrected without operator intervention.

Trend. The accumulation of several hours of data at two-minute intervals.

Trend Parameter. Heart Rate/Pulse Rate, P1, P2, SpO₂, INCO₂, ETCO₂, temperature, NIBP and RR.

Turbocuf Mode. The mode used to acquire as many NIBP measurements as possible in five minutes.

UA. Umbilical artery (label for an invasive blood pressure channel).

Unfreeze. Returns the waveforms to active display. See also Freeze.

UV. Umbilical vein (label for an invasive blood pressure channel).

Vital Sign Parameter. The measurements obtained from patient channels (such as, heart rate, systolic, diastolic, mean, pulse rate, SpO₂, CO₂, etc.).

Waveform Window. The area in which waveforms are displayed.

Waveform/Status Window. See Waveform Window or Status Window.

Window. An area on the display screen in which information is displayed.

YSI. An acronym for Yellow Springs Instrument Company.

Zeroing. The process by which an invasive pressure zero reference is obtained so that pressures can be related to atmospheric pressure. This process also nulls out any residual pressure indicated by a transducer with zero pressure applied.

Index

A

ac adapter connector 10
 Accessories
 Products & Accessories book 5
 Acuity System 85
 Acuity menu 87
 connecting 85
 Intended use 85
 Network Fault message 88
 printing at Acuity 87
 Adult Mode 42
 Alarm Holdoffs 73, 111
 ALARM light 10
 Alarm Limits Menu 18
 ALARM PRINT setting 25, 81
 ALARM TONE setting 20
 ALARM(S) OFF light 10
 Alarms
 limits for CO₂ 58
 Menu 18
 setting quickly (STAT SET) 74
 specifications 111
 ALARMS button 20
 Alarms Menu
 STAT SET button 74
 Apnea 59
 alarm limit 63
 Ticket 81
 APNEA TICKET setting 25
 ART, label for arterial pressure 40
 Artifact affecting ECG 33
 Artifact reduction with C-LOCK (SpO₂) 55
 Artifact with NIBP 42, 45, 50, 78, 80, 83
 AUTO PRINT setting 25
 AUTO/MAN button 46
 Automatic intervals (NIBP) 48
 Automatic NIBP measurements 46, 48
 Automatic trend prints 83

B

Battery
 care and maintenance 91
 charging light 10
 removal, effect on programmable settings 95
 replacement 94
 storage 95
 voltage 11, 92
 Breath rate measurements 58
 Buttons
 menu 17
 monitor 16

C

CANCEL button 40
 CHANGE button 20, 25
 Changing printer paper 96
 Cleaning instructions 93
 C-LOCK, SpO₂ measurement 55
 CO₂ 8
 accessories 61, 64
 alarm limits 58
 and intubated patients 57, 66
 and N₂O 62
 gas compensation 57
 intended use 57
 Mainstream CO₂ 61
 Mainstream CO₂ messages 66
 measurements 58
 Menu 1 17
 Menu 2 17
 N₂O 57
 printing waveforms 80
 Sidestream CO₂ 64
 Sidestream CO₂ messages 67
 specifications 108
 sweep speed 62
 CO₂ Menu 1
 mm/sec button 59, 62
 RANGE button 59, 62

- CO2 Menu 2
 - FLOWRATE button 60
 - GAS COMP button 59, 60, 62
 - RESPONSE button 59, 60, 63
 - SOURCE button 60
- Connectors
 - ac adapter 10
 - ECG 31
 - INV PRS 37
 - NIBP 44
 - patient 13
 - power input 10
 - temperature probes 50
- CONTINUOUS (print speed) setting 25
- Cuff (NIBP)
 - placement 44
 - sizes 44
- CURRENT SOURCE setting 20
- Custom patient modes 23
- Customer services 97
- CVP, label for central venous pressure 40

D

- DATE setting 23
- dc power source 10
- DECIMAL setting 23
- Default alarm limits
 - Patient Mode 11
- Defibrillator synchronization
 - specifications 101
- Defibrillators
 - use with ECG 30
- Disinfection instructions 93
- Display
 - Propaq screen 15
 - specifications 112
 - SpO2 53, 54
 - waveform priorities 22
- Display trends 78
- Displaying
 - ECG 33
 - INV PRS 39
 - NIBP 45

E

- ECG
 - accessories 31
 - artifact 33
 - connector 31
 - displaying 33
 - electrode placement 32
 - filter 36
 - Menu 1 17

- Menu 2 17
- messages 36
- pacemaker patients 35
- pre-gelled electrodes 31
- printing waveforms 79
- specifications 99
- Status Window 34
- waveform priorities 22
- ECG Bandwidth 30, 34
- ECG BANDWIDTH setting 34
- ECG LEAD button 33
- ECG Menu 2
 - CHANGE button 34
 - NEXT button 34
- ECG SIZE button 33, 34
- ECG/RESP
 - Menu 1 33
 - Menu 2 33
- ECG/RESP button 33
- ECG/RESP Menu 1
 - ECG SIZE button 33, 34
- ECG/RESP Menu 2
 - ECG LEAD button 33
 - RESP SZE button 34
- Electrodes
 - placement 32
 - pre-gelled 31
- Electrosurgical machines
 - use with ECG 30, 32
- EMP (*see* Expansion Module with Printer)
- Environmental (monitor) specifications 113
- Environmental limits
 - operating 95
 - storage 95
- Equipment Alerts
 - Printer Fault 26
 - PROGRAM FAULT 11, 75
- ESIS 30
- Expansion Module
 - CO2 8
 - Printer 8
 - SpO2 8
- Extended Mode 30, 34
- Extended storage 95

F

- Factory defaults
 - specifications 118
- Factory patient modes 23
- False alarms with SpO2 53, 55
- FILTER setting 23, 36
- FLOWRATE button 60
- FORMAT (P1/P2) buttons 40
- FREEZE/UNFREEZE button 16, 26

Fuses

- replacing, Universal Power Adapter 90

G

- GAS COMP button 59, 60, 62

- Gas compensation for CO₂ 57, 62

H

- HP connector-compatible option 9

- HR/PR TONE setting 21, 34

I

- ICP, label for intracranial pressure 40

- Impedance Pneumography (*see* RESP)

- INSERV button 19, 26

- In-service mode 26

- simulated trend data 26

- using with NIBP 27

- what you can do 27

- what you cannot do 27

- Inspect the monitor 93

- INTERVAL button 46

- Introduction 7

- Intubated patients 57

- INV PRS button 38, 39

- INV PRS Menu 1

- CANCEL button 40

- RANGE button 40

- RESCALE button 40

- ZERO (P1/P2) buttons 40

- INV PRS Menu 2

- FORMAT (P1/P2) buttons 40

- LABEL (P1/P2) buttons 40

- Invasive pressure

- accessories 37

- connectors 37

- displaying 39

- intended use 30, 37

- Menu 1 17

- Menu 2 17

- messages 38, 41

- numerics 39

- numerics formats 40

- preparing for monitoring 38

- printing waveforms 79

- range 37

- rezeroing a transducer 39

- scales 40

- specifications 103

- transducer sensitivity 37

- transducer zeroing 38

- Invasive pressure labels

- ART (arterial) 40

- CVP (central venous pressure) 40

- ICP (intracranial pressure) 40

- P1 40

- P2 40

- PA (pulmonary artery) 40

- selecting 39

- UA (umbilical artery) 40

- UV (umbilical vein) 40

L

- LABEL (P1/P2) buttons 40

- Learning the Propaq 26

- Left side panel, patient connectors 13

- Lights

- ALARM 10

- ALARM(S) OFF 10

- battery charging 10

- Loading printer paper 96

- Loudness

- heart tone 34

M

- Main Menu 17

- ECG/RESP button 33

- INV PRS button 38, 39

- NIBP button 45, 47

- SETUP button 20

- SpO₂/CO₂ button 17

- MAIN MENU button 16

- Mainstream Capnography (*see* CO₂)

- Mainstream CO₂

- monitoring 61

- Maintenance

- monitor care 95

- power adapters 89

- printer 96

- replacing monitor fuse 92

- service intervals 94

- Marriott Configuration (MCL), electrode placement 32

- Menus

- Alarm Limits 18

- Alarms 18

- CO₂ Menu 1 17, 59

- CO₂ Menu 2 17

- CO₂ Menu2 59

- ECG Menu 1 17

- ECG Menu 2 17

- ECG/RESP 33

- INV PRS Menu 1 17, 40

- INV PRS Menu 2 17, 40

- Main 17

- NIBP 17, 46
- Printer Setup 19
- Service 19
- Setup Menu 1 18
- SpO2 53, 54
- SpO2 Menu 1 17
- SpO2 Menu 2 17
- Trends 18
- Wave Select 19, 22
- Messages
 - ECG 36
 - INV PRS 41
 - Mainstream CO2 66
 - NIBP 48–49
 - Printer Fault 26
 - RESP 36
 - Sidestream CO2 67
 - SIMULATING 26
 - TEMP 51
- mm/sec button 59, 62
- Modem-Propaq option 9
- Monitor buttons
 - FREEZE/UNFREEZE button 16, 26
 - MAIN MENU button 16
 - START/STOP button 16
- Monitor care 95
 - fuse replacement 92
- Monitor Mode 30, 34
- Monitor settings
 - ALARM TONE 20
 - CURRENT SOURCE 20
 - DATE 23
 - DECIMAL 23
 - ECG BANDWIDTH 34
 - FILTER 23, 36
 - HR/PR TONE 21, 34
 - PACER DISPLAY 34
 - PATIENT MODE 21
 - RESP (ON/OFF) 34
 - RESP LEAD 34
 - SELECTED SOURCE 20
 - SWEEP (mm/s) 20
 - TEMP F/C 23
 - TIME/DAY 22
- MORE button 20, 25
- Motion artifact and NIBP 42, 45, 50, 78, 80, 83

N

- Neonatal Mode 42
- Network Fault message 88
- NEXT button 20, 25
- NIBP
 - accessories 44
 - adult mode 42

- Artifact 42, 45, 50, 78, 80, 83
 - automatic intervals 48
 - automatic measurements 48
 - cardiopulmonary bypass 42
 - connector 44
 - cuff placement 44
 - cuff sizes 44
 - displaying 45
 - Menu 17, 46
 - messages 48–49
 - Motion artifact 42, 45, 50, 78, 80, 83
 - neonatal mode 42
 - pediatric mode 42
 - preparing for measurements 44
 - specifications 104
 - Symbol in display and prints 45, 78, 80, 83
 - Ticket 80
 - waveform window, displayed in 47
- NIBP button 45, 47
- NIBP Menu
 - AUTO/MAN button 46
 - INTERVAL button 46
 - START button 46
 - STOP button 46
 - TURBOCUF button 46
- NIBP TICKET setting 25
- NO INSRV button 19
- Noninvasive blood pressure (*see* NIBP)
- NXT TRND button 77, 78, 83

O

- Options
 - CO2 8
 - HP-compatible side panel 9
 - Printer 8
 - RESP 8
 - SpO2 8
- Ordering 97
- OXYCRG button 77
- OXYCRG ON ALARM setting 25
- Oxygen saturation display 53, 54

P

- PA, label for pulmonary artery pressure 40
- Pacemakers
 - detection 35
 - use with patients 35
- PACER DISPLAY setting 34
- Paper, printer 96
- Patient artifact 33
- Patient connectors 13
 - CO2 13
 - ECG 13

- HP-option 13
- INV PRS 13
- NIBP 13
- SpO2 13
- TEMP 13
- Patient Mode 31, 59
 - Adult 42
 - Custom 23
 - default alarm limits 11
 - factory default 11
 - Neonatal 42
 - Pediatric 42
- PATIENT MODE setting 21
- Pediatric Mode 42
- Physical (monitor) specifications 114
- Physical inspection 93
- Power
 - input connector 10
 - specifications 116
- Power adapters 89
 - specifications 117
- Powerup patient modes 23
- Powerup tones
 - expansion module/SpO2 module 11
 - monitor 11
- PR TREND button 25, 83
- PREV MENU button 25
- PRINT button 77, 83
- PRINT TRENDS button 26, 83, 96
- Printer 8
 - loading paper 96
 - maintenance 96
 - print speed (continuous measurements) 25
 - PRINT TRENDS button 26, 83, 96
 - setup 25
 - SIMULATED DATA 27
 - SNAPSHOT button 26, 79
 - specifications 115
 - START/STOP button 26, 79, 96
 - test strip 26
- PRINTER button 20, 80
- Printer Fault equipment alert 26
- Printer Menu
 - CHANGE button 25
 - MORE button 25
 - NEXT button 25
 - PR TREND button 25
 - PREV MENU button 25
- Printer settings
 - ALARM PRINT 25
 - APNEA TICKET 25
 - AUTO PRINT 25
 - CONTINUOUS (print speed) 25
 - NIBP TICKET 25
 - OXYCRG ON ALARM 25

- Printer Setup Menus 19
- Printing 80
 - alarm prints 81
 - Apnea Ticket 81
 - automatic trends 83
 - automatically 79, 83
 - CO2 waveforms 80
 - ECG waveforms 79
 - INV PRS waveforms 79
 - NIBP Ticket 80
 - NIBP Trend 80
 - OxyCRG 82
 - OxyCRG on Alarm 82
 - PR TREND button 83
 - PRINT button (*see also* Trends Menu) 83
 - Printer Setup window 81
 - RESP waveforms 80
 - Setup Menu 2 80
 - speed 79
 - SpO2 waveforms 79
 - sweep speeds with SNAPSHOT 80
 - trends 83
 - trends according to shift 83
 - with an expansion module 79
- Probes, temperature 50
- Products & Accessories book 5
- Programmable settings
 - effect of battery removal 95
 - lost 11, 75
- Propaq
 - buttons 16
 - documentation set 5
 - screen display 15
- Propaq CS
 - Physical inspection 93
- Propaq-to-Acuity option overview 9
- Pulse oximetry (*see* SpO2)

R

- RANGE button 40, 59, 62
- Real-time ECG analog
 - specifications 101
- REMOVE CUFF FROM PATIENT 49, 75
- REMOVE CUFF FROM PATIENT message 75
- RESCALE button 40
- RESP 8
 - intended use 29
 - messages 36
 - printing waveforms 80
 - specifications 102
 - sweep speed 62
- RESP LEAD setting 34
- RESP setting 34
- RESP SZE button 34

RESPONSE button 59, 60, 63
 RESPONSE time (SpO2) 54
 Returning monitor for service 97
 Rezeroing a transducer 39
 Right side panel
 fuse replacement 92
 system controls 9

S

Safety summary 1
 Screen display 15
 SELECTED SOURCE setting 20
 Service intervals 94
 Service Menu 19
 SETUP button 20
 Setup Menu 1 18
 ALARMS button 20
 MORE button 20
 TRENDS button 20
 Setup Menu 2
 CHANGE button 20
 MORE button 20
 NEXT button 20
 PRINTER button 20
 WAVE SEL button 20
 Side panels
 left, patient connectors 13
 right, system controls 9
 Sidestream CO2 64
 SIMULATING, on monitor display 26
 Size, waveforms 34
 SNAPSHOT button 26, 79
 SOURCE button 60
 Specifications
 alarms 111
 CO2 108
 defibrillator synchronization 101
 display 112
 ECG 99
 environmental 113
 factory defaults 118
 INV PRS 103
 NIBP 104
 physical 114
 power 116
 power adapters 117
 printer 115
 real-time ECG analog 101
 RESP 102
 SpO2 106
 TEMP 105
 trends 111
 SpO2 8
 Adjust waveform size 53, 54

C-LOCK 55
 Display 53, 54
 Menu 1 17
 Menu 2 17
 NIBP and SpO2 53, 54
 plethysmograph 79
 printing waveforms 79
 Reducing false alarms 53, 55
 relative gain 79
 Response time selection 54
 Sensor selection 53, 54
 size indicator 79
 specifications 106
 SpO2 Menus 53, 54
 Spot-Check monitoring 56
 Standby Mode 56
 SpO2/CO2 button 17
 Spot-Check SpO2 monitoring 56
 STANDBY and SpO2 56
 Standby Mode, SpO2 56
 START/STOP button (NIBP) 16, 46
 START/STOP button (Printer) 26, 79, 96
 STAT SET 74
 STAT SET button 74
 Status Windows
 ECG 34
 STBY message, SpO2 STANDBY 56
 Storage
 battery 95
 monitor 95
 printer paper 96
 SWEEP (mm/s) setting 20
 Sweep speed (CO2, RESP) 62
 Symbol
 In NIBP displays and prints 45, 78, 80, 83
 Symbols
 defined 3
 Synchronizing R-waves, C-LOCK 55

T

Technical service and training 97
 TEMP F/C setting 23
 Temperature
 accessories 50
 connectors 50
 intended use 50
 messages 51
 preparing for monitoring 50
 specifications 105
 TIME/DAY setting 22
 Tone
 HR/PR (volume) 34
 powerup 11

Trends

- clearing data 78
- column labels 78
- continuous monitoring 77
- how to display 78
- how to select 78
- maximum number of samples 77
- Menu 18, 77
- NIBP 78
- NIBP and symbol 78
- NXT TRND button 77, 78, 83
- OXYCRG button 77
- P1 77
- P2 77
- PRINT button 77, 83
- printing each shift 83
- printing one 83
- printing several 83
- programmable default 78
- RESP 77
- specifications 111
- status window 77
- Symbol and NIBP 78
- TEMP 77
- TRENDS button 78
- TRENDS button 20, 78
- TURBOCUF button 46

U

- UA, label for umbilical artery 40
- Universal Power Adapter
 - voltage selection 89
- UV, label for umbilical vein 40

V

- Verifying Patient Mode 11
- Verifying powerup tone 11
- Voltage
 - battery 11
 - checking battery 92
- Volume
 - heart tone 34

W

- WAVE SEL button 20
- Wave Select
 - Menu 19
 - window 22
- Wave Select Menu
 - INSERV button 19, 26
 - NEXT button 22

- NO INSRV button 19
- ON/OFF button 22

Waveform

- SpO2 53, 54

Waveforms

- display priorities 22
- ECG 22
- scales 40, 62
- size 34

Windows

- Propaq screen 15

Z

- ZERO (P1/P2) buttons 40

Zeroing

- messages 38
- transducers 38

